



VENTANA BATIENTE VLP46

Una ventana batiente, también llamada ventana practicable o ventana abatible, es sencillamente la ventana más típica que nos podemos imaginar. Técnicamente, es aquella que permite la apertura interior y exterior de una o dos hojas que giran sobre los marcos laterales, a los que están unidas mediante bisagras.



CARACTERÍSTICAS

- Peso de ventana batiente 80 KG
- Acristalamiento
- Cristales monolíticos 6 mm y 8 mm
- Cristales insulados hasta 24 mm
- Armados con cortes a 45 grados, unión escuadras



TIPOLOGÍA

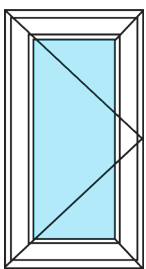

1 Hoja Apertura Interior
VLP46

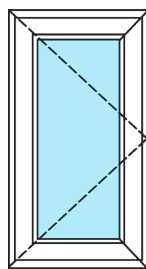

1 Hoja Apertura Exterior
VLP46

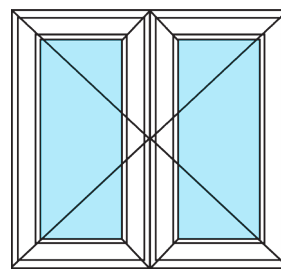

2 Hojas Apertura Interior
VLP46

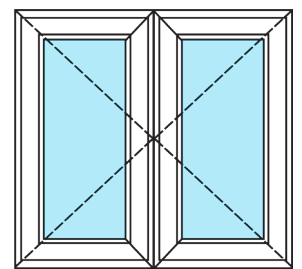

2 Hojas Apertura Exterior
VLP46



VENTANA BATIENTE INTERIOR

VLP46

PERFILES

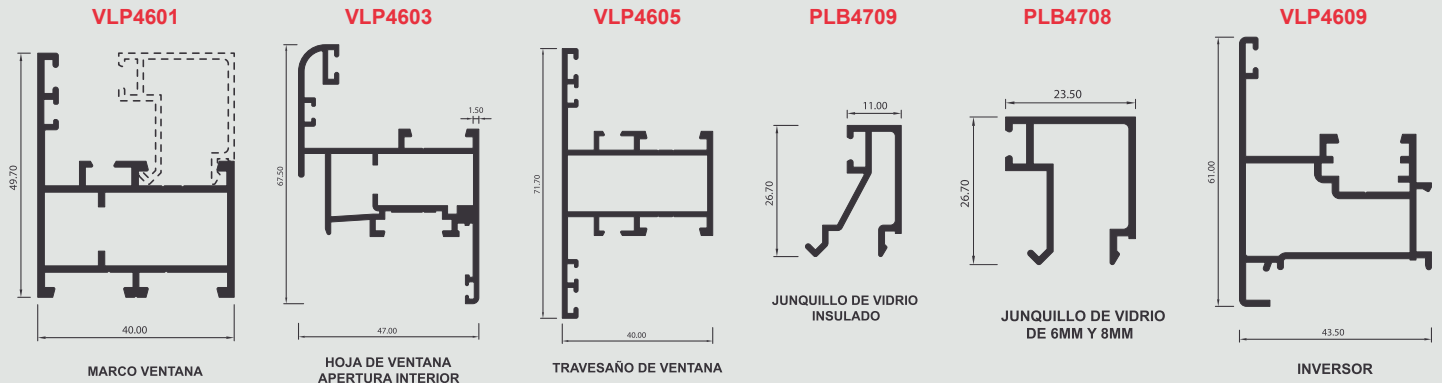

ACCESORIOS



RAV0001248
MANIJA 9500 BLANCO
PARA VENTANA INTERIOR
RAV0001249
MANIJA 9500 NEGRO
PARA VENTANA INTERIOR
RAV0001250
MANIJA 9500GRIS
PARA VENTANA INTERIOR



RAV0001237
BISAGRA 5080 GRIS PARA
VENTANA EXT/ INT VLP46
RAV0001264
BISAGRA 5080 BLANCO PARA
VENTANA EXT/ INT VLP46
RAV0001265
BISAGRA 5080 NEGRO PARA
VENTANA EXT/INT VLP46



RAV0001236
KIT DE CIERRE PARA VENTANA
INTERIOR PONT. 503



RAV0001205
ESCUADRA 24.5 x 13.80
PARA MARCO Y HOJA



RAV0001198
ESCUADRA DE ALINEAMIENTO
5X2X32mm



RAV0001204
UNIÓN TRAVESAÑO
14.7 x 18 1518 DE VENTANA
***USAR CUANDO SE PONGAN
TRAVESAÑOS LNIERMEDIOS**



ESCUADRA DE
ALINEAMIENTO
HOJA
RAV0001295



RAV0001201
BURLETE EPDM
JUNTA DE HERMETICIDAD
Y ACRISTALAMIENTO



RAV0001208
VIERTEAGUAS PVC NEGRO
RAV0001209
VIERTEAGUAS PVC BLANCO
RAV0001210
VIERTEAGUAS PVC GRIS



CUÑA MÓVIL DE PRESIÓN
RAV0001137 - 3mm
RAV0001157 - 5mm



TAPA DE NYLON PARA
INVERSOR DE
SISTEMA PRACTICABLE
RAV0001212



KIT PASADOR PARA
VENTANA INT/EXT.
2º HOJA
RAV0001238



PLETINA PVC
TRANSMISIÓN
PARA CIERRES
RAV0001202



BURLETE EPDM
DOBLE CONTACTO
RAV0001200



VENTANA BATIENTE INTERIOR 1 HOJA

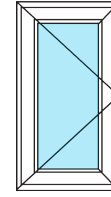

PERFILES

CÓDIGO	PERFIL	UND	TIPO DE CORTE	CANTIDAD
VLP4601	MARCO VENTANA	4	45º	1 PERÍMETRO
VLP4603	HOJA VENTANA APERTURA INTERIOR	4	45º	1 PERÍMETRO
PLB4708	JUNQUILLO DE VIDRIO DE 6 MM Y 8 MM	4	90º	1 PERÍMETRO

ACCESORIOS

ITEM	DESCRIPCIÓN	UND	CANTIDAD
RAV0001248	MANIJA BLANCO PARA VENTANA INTERIOR VLP46 9500/ 1165300200 - MR	UND	1
RAV0001249	MANIJA NEGRO PARA VENTANA INTERIOR VLP46 9500/ 1165300210 - MR	UND	
RAV0001250	MANIJA GRIS PARA VENTANA INTERIOR VLP46 9500/ 1165300208 - MR	UND	
RAV0001237	BISAGRA GRIS PARA VENTANA EXT/INT VLP46 CE 5080 INOX 1106310101 MR	UND	2
RAV0001264	BISAGRA BLANCO PARA VENTANA EXT/INT VLP46 CE 5080 INOX 1106310200 MR	UND	
RAV0001265	BISAGRA NEGRO PARA VENTANA EXT/INT VLP46 CE 5080 INOX 1106310210 MR	UND	
RAV0001205	ESCUADRA 24.5 X 13.80 PARA MARCO Y HOJA DE VLP46	UND	8
RAV0001238	KIT PASADOR PARA VENTANA INT/ EXT 2° HOJA VLP46 PONT.503 1181108100 - MR	KIT	1
RAV0001236	KIT DE CIERRE PARA VENTANA INTERIOR VLP46 PONT.503 1181121100	KIT	1
RAV0001198	ESCUADRA DE ALINEAMIENTO 5X2X32 PARA SERIE PRACTICABLE	UND	8
RAV0001295	ESCUADRA DE ALINEAMIENTO HOJA	UND	4
RAV0001200	BURLETE EPDM DOBLE CONTACTO 309.R041.02.TP PARA SISTEMA PRACTICABLE (HOJA)	MTS	1 PERÍMETRO
RAV0001201	BURLETE EPDM DE HERMETICIDAD 300.A200.01.EB PARA SISTEMA PRACTICABLE (MARCO Y HOJA)	MTS	2 PERÍMETROS
RAV0001202	PLETINA DE TRANSMISIÓN PVC 815.R250.01.RC PARA SISTEMA PRACTICABLE	MTS	1 PERÍMETRO
RAV0001137	CUÑA DE 3 MM PARA VIDRIO DE 8 MM	MTS	1 PERÍMETRO
RAV0001157	CUÑA DE 5 MM PARA VIDRIO DE 6 MM	MTS	1 PERÍMETRO

Matriz

Matriz múltiple
sistema practicable
AP40/LIM



Punzadora Manual

Para Sistema
Practicable
**Modelo: C26-1842-
N 18x12**
***Solo uso
en escuadras**





CORTE VERTICAL

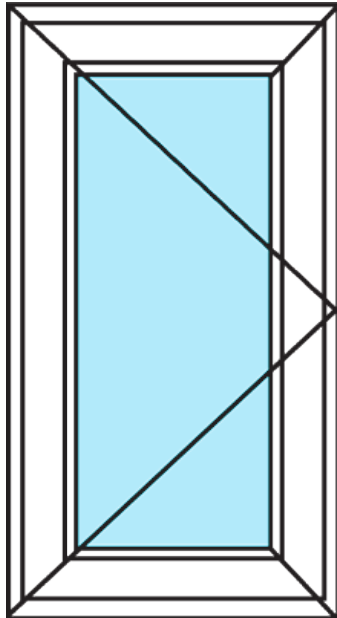

1 HOJA APERTURA INTERIOR
VLP46

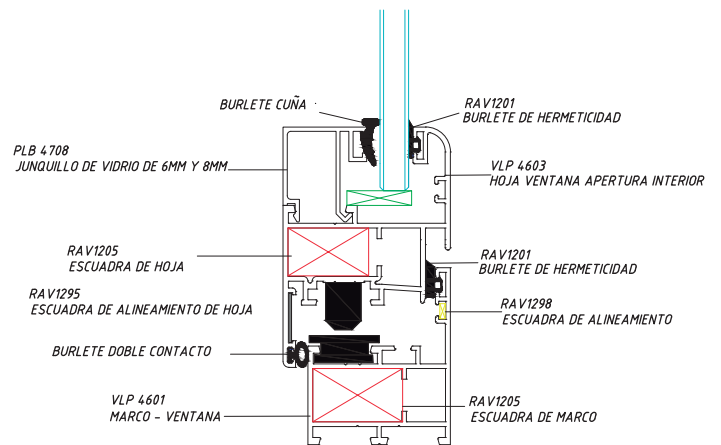
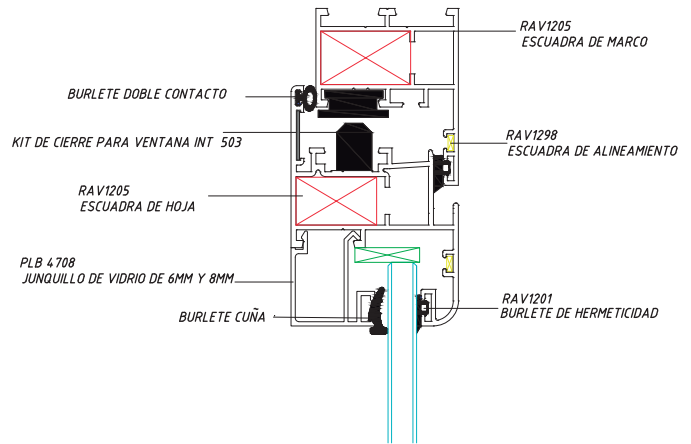

CORTE HORIZONTAL

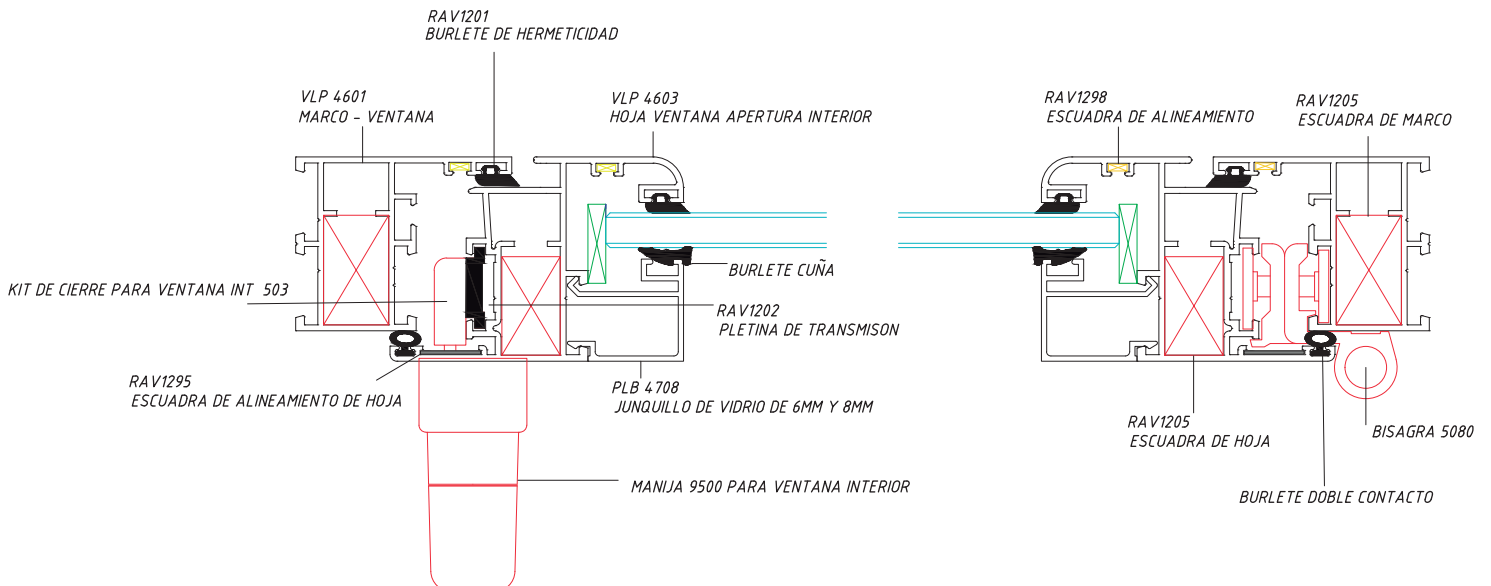



VENTANA BATIENTE INTERIOR 2 HOJAS

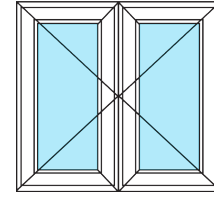

PERFILES

CÓDIGO	PERFIL	UND	TIPO DE CORTE	CANTIDAD
VLP4601	MARCO VENTANA	4	45º	1 PERÍMETRO
VLP4603	HOJA VENTANA APERTURA INTERIOR	8	45º	1.5 PERÍMETROS
PLB4708	JUNQUILLO DE VIDRIO DE 6 MM Y 8 MM	8	90º	1.5 PERÍMETROS
VLP4609	INVERSOR	1	90º	1 VERTICAL

ACCESORIOS

ITEM	DESCRIPCIÓN	UND	CANTIDAD
RAV0001248	MANIJA BLANCO PARA VENTANA INTERIOR VLP46 9500/ 1165300200 - MR	UND	1
RAV0001249	MANIJA NEGRO PARA VENTANA INTERIOR VLP46 9500/ 1165300210 - MR	UND	
RAV0001250	MANIJA GRIS PARA VENTANA INTERIOR VLP46 9500/ 1165300208 - MR	UND	
RAV0001237	BISAGRA GRIS PARA VENTANA EXT/INT VLP46 CE 5080 INOX 1106310101 MR	UND	4
RAV0001264	BISAGRA BLANCO PARA VENTANA EXT/INT VLP46 CE 5080 INOX 1106310200 MR	UND	
RAV0001265	BISAGRA NEGRO PARA VENTANA EXT/INT VLP46 CE 5080 INOX 1106310210 MR	UND	
RAV0001205	ESCUADRA 24.5 X 13.80 PARA MARCO Y HOJA DE VLP46	UND	12
RAV0001315	KIT PASADOR PARA VENTANA INT/ EXT 2º HOJA VLP46 PONT.503 1181108100 - MR	PAR	1
RAV0001198	ESCUADRA DE ALINEAMIENTO 5X2X32 PARA SERIE PRACTICABLE	UND	12
RAV0001236	KIT DE CIERRE PARA VENTANA INTERIOR VLP46 PONT.503 1181121100	KIT	1
RAV0001200	BURLETE EPDM DOBLE CONTACTO 309.R041.02.TP PARA SISTEMA PRACTICABLE (HOJA)	MTS	2 PERÍMETRO
RAV0001201	BURLETE EPDM DE HERMETICIDAD 300.A200.01.EB PARA SISTEMA PRACTICABLE (MARCO Y HOJA)	MTS	4 PERÍMETRO
RAV0001202	PLETINA DE TRANSMISIÓN PVC 815.R250.01.RC PARA SISTEMA PRACTICABLE	MTS	1 PERÍMETRO
RAV0001212	TAPA DE NYLON PARA INVERSOR DE SISTEMA PRACTICABLE	UND	1
RAV0001137	CUÑA DE 3 MM PARA VIDRIO DE 8 MM	MTS	2 PERÍMETRO
RAV0001157	CUÑA DE 5 MM PARA VIDRIO DE 6 MM	MTS	2 PERÍMETRO
RAV0001295	ESCUADRA DE ALINEAMIENTO HOJA	UND	8

Matriz

Matriz múltiple
sistema practicable
AP40/LIM



Punzadora Manual

Para Sistema
Practicable
**Modelo: C26-1842-
N 18x12**
***Solo uso
en escuadras**





CORTE VERTICAL

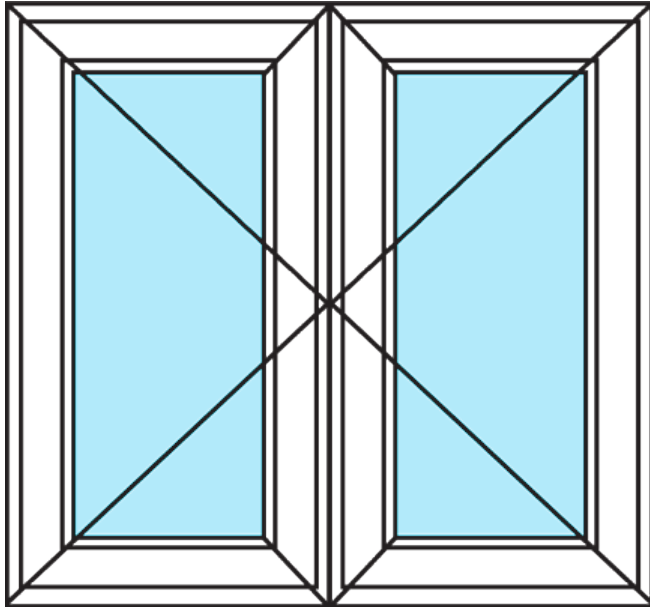

2 HOJAS APERTURA INTERIOR
VLP46

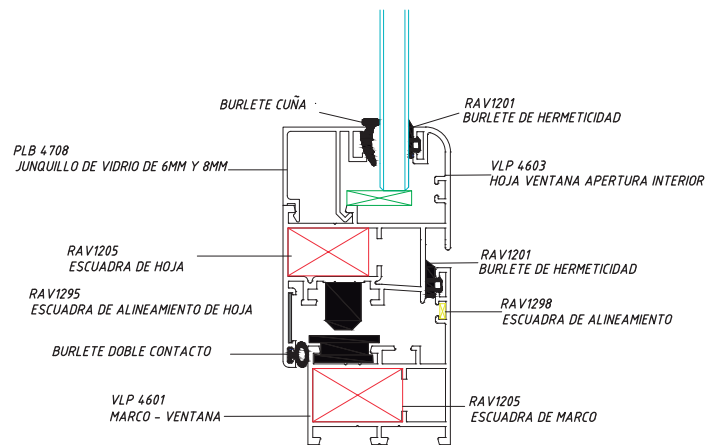
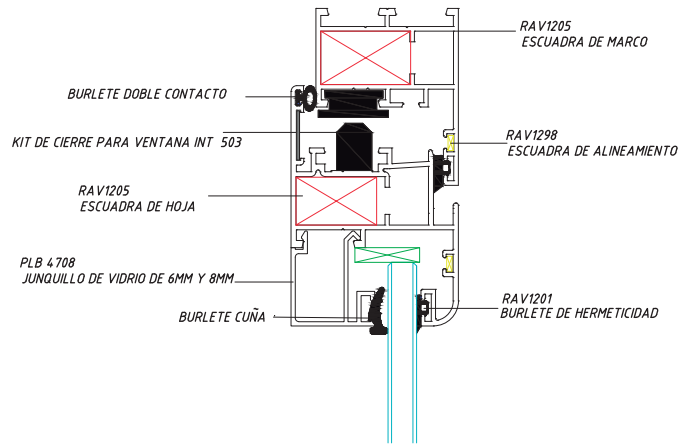

CORTE HORIZONTAL





TABLA DE DESCUENTOS SERIE BATIENTE INTERIOR VLP46



1 HOJA

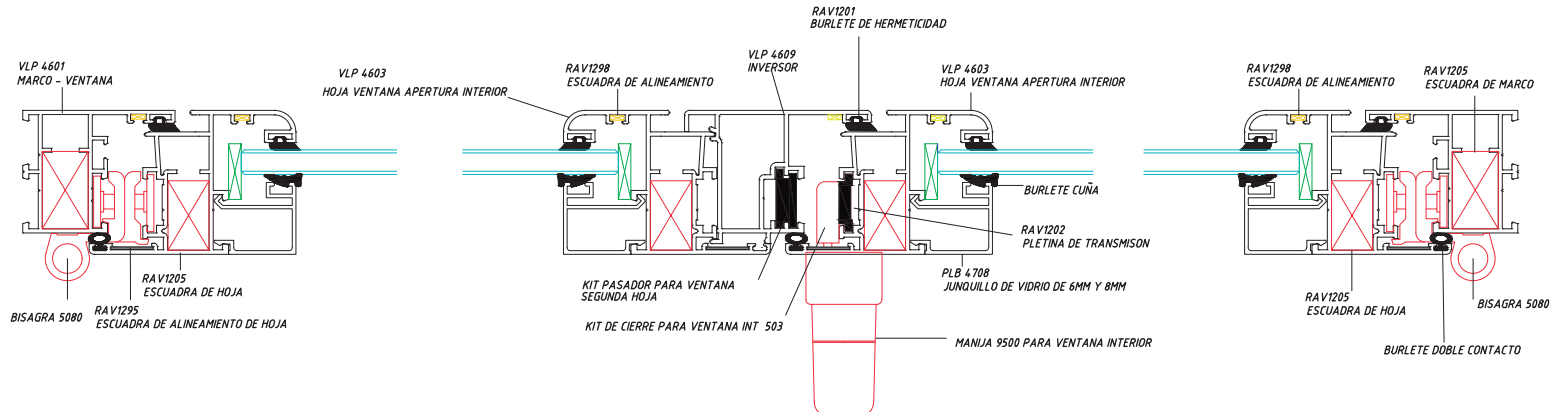
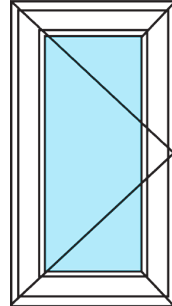
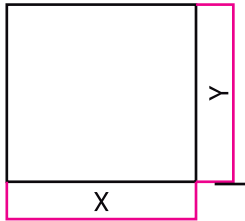
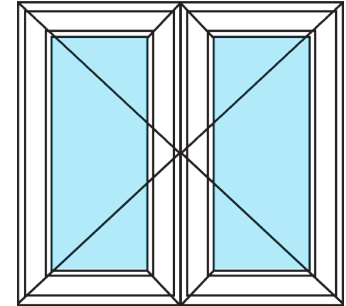

2 HOJAS

PERFIL	FORMULA	CANT	FORMULA	CANT
VLP4601 MARCO HORIZONTAL	X	2	X	2
VLP4601 MARCO VERTICAL	Y	2	Y	2
VLP4603 HOJA HORIZONTAL	X - 46	2	X/2 - 26	4
VLP4603 HOJA VERTICAL	Y - 46	2	Y - 46	4
PLB4708 JUNQUILLO HORIZONTAL	X - 134	2	X/2 - 113	4
PLB4708 JUNQUILLO VERTICAL	Y - 134	2	Y - 134	4
VLP4609 INVERSOR	-	-	Y - 110	1

VIDRIOS

BASE	X - 142	1	X/2 - 124	2
ALTURA	Y - 140		Y - 140	



VENTANA BATIENTE EXTERIOR VLP46 PESADO

PERFILES

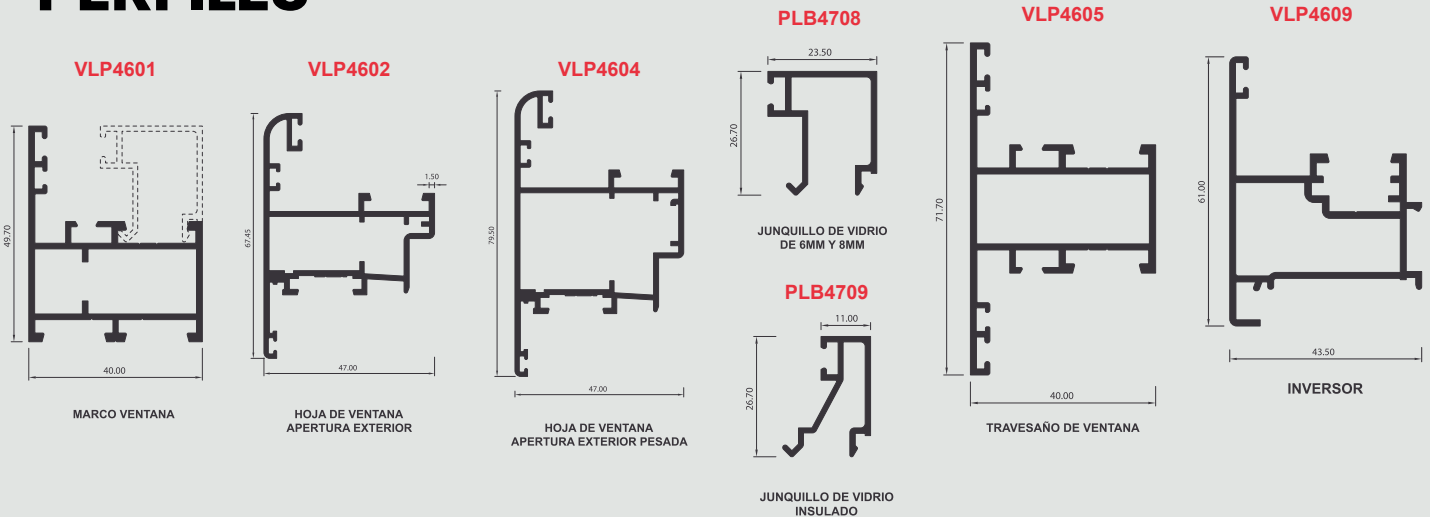

ACCESORIOS



OPCIONAL:

RAV0001268
MANIJA 9560 BLANCO
RAV0001299
MANIJA 9560 NEGRO
RAV0001252
MANIJA 9560GRIS



RAV0001237
BISAGRA 5080 GRIS PARA VENTANA EXT/INT VLP46
RAV0001264
BISAGRA 5080 BLANCO PARA VENTANA EXT/INT VLP46
RAV0001265
BISAGRA 5080 NEGRO PARA VENTANA EXT/INT VLP46



BURLETE EPDM DOBLE CONTACTO
RAV0001200



RAV0001205
ESCUADRA 24.5 x 13.80 PARA MARCO Y HOJA



RAV0001198
ESCUADRA DE ALINEAMIENTO 5X2X32mm



RAV0001204
UNION TRAVESAÑO 14.7 x 18 1518 DE VENTANA
***USAR CUANDO SE PONGAN TRAVESAÑOS LNIERMEDIOS**



CUÑA MÓVIL DE PRESIÓN
RAV0001137 - 3mm
RAV0001157 - 5mm



RAV0001201
BURLETE EPDM JUNTA DE HERMETICIDAD Y ACRISTALAMIENTO



RAV0001208
VIERTEGUAS PVC NEGRO
RAV0001209
VIERTEGUAS PVC BLANCO
RAV0001210
VIERTEGUAS PVC GRIS



RAV0001206
ESCUADRA 24.5 x 26.2 PARA MARCO PUERTA PLB47



ESCUADRA DE ALINEAMIENTO HOJA
RAV0001295



TAPA DE NYLON PARA INVERSOR DE SISTEMA PRACTICABLE
RAV0001212



KIT PASADOR PARA VENTANA INT/EXT 2º HOJA
RAV0001238



VENTANA BATIENTE EXTERIOR 1 HOJA

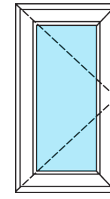

PERFILES

CÓDIGO	PERFIL	UND	TIPO DE CORTE	CANTIDAD
VLP4601	MARCO VENTANA	4	45º	1 PERÍMETRO
VLP4604	HOJA VENTANA APERTURA EXTERIOR PESADA	4	45º	1 PERÍMETRO
PLB4708	JUNQUILLO DE VIDRIO DE 6 MM Y 8 MM	4	90º	1 PERÍMETRO

ACCESORIOS

ITEM	DESCRIPCIÓN	UND	CANTIDAD
RAVO001239	MANIJA NEGRO PARA PROYECTANTE VLP46 9560/1154300210-MR	UND	1
RAVO001252	MANIJA GRIS PARA PROYECTANTE VLP46 9560/1154300208-MR	UND	
RAVO001258	MANIJA BLANCO PARA PROYECTANTE VLP46 9560/1154300200-MR	UND	
RAVO001237	BISAGRA GRIS PARA VENTANA EXT/INT VLP46 CE 5080 INOX 1106310101 MR	UND	2
RAVO001264	BISAGRA BLANCO PARA VENTANA EXT/INT VLP46 CE 5080 INOX 1106310200 MR	UND	
RAVO001265	BISAGRA NEGRO PARA VENTANA EXT/INT VLP46 CE 5080 INOX 1106310210 MR	UND	
RAVO001205	ESCUADRA 24.5 x 13.80 PARA MARCO Y HOJA DE VLP46	UND	4
RAVO001206	ESCUADRA 24.5 x 26.2 PARA MARCO PUERTA PLB47-HOJA PESADA VLP4604	UND	4
RAVO001198	ESCUADRA DE ALINEAMIENTO 5X2X32 PARA SERIE PRACTICABLE	UND	8
RAVO001200	BURLETE EPDM DOBLE CONTACTO 309.R041.02.TP PARA SISTEMA PRACTICABLE (HOJA)	MTS	1 PERÍMETRO
RAVO001201	BURLETE EPDM DE HERMETICIDAD 300.A200.01.EB PARA SISTEMA PRACTICABLE (MARCO Y HOJA)	MTS	2 PERÍMETROS
RAVO001137	CUÑA DE 3 MM PARA VIDRIO DE 8 MM	MTS	1 PERÍMETRO
RAVO001157	CUÑA DE 5 MM PARA VIDRIO DE 6 MM	MTS	1 PERÍMETRO
RAVO001295	ESCUADRA DE ALINEAMIENTO HOJA	UND	4

Matriz

Matriz múltiple
sistema practicable
AP40/LIM



Punzadora Manual

Para Sistema
Practicable
**Modelo: C26-1842-
N 18x12**
***Solo uso
en escuadras**





CORTE VERTICAL

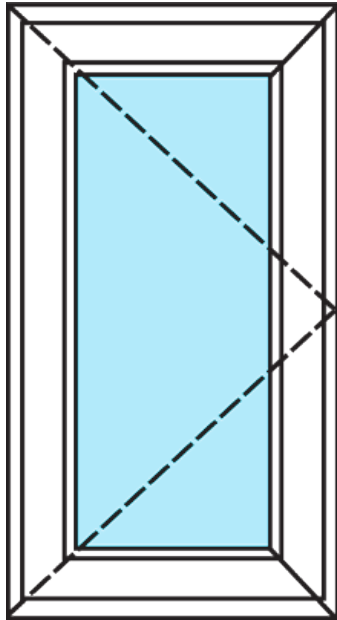

1 HOJA APERTURA EXTERIOR
VLP46

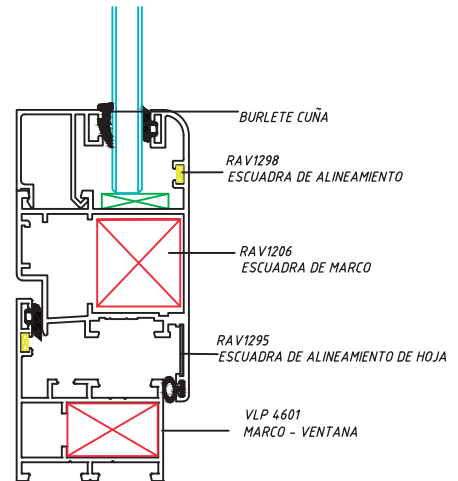
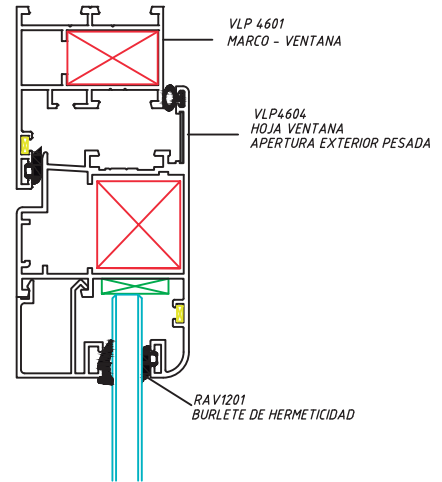

CORTE HORIZONTAL

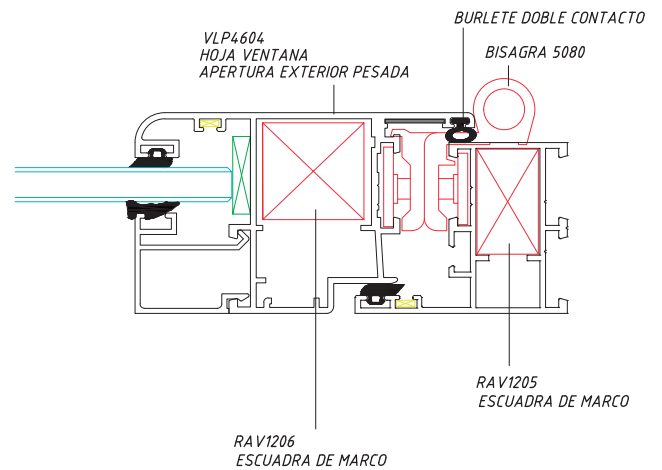
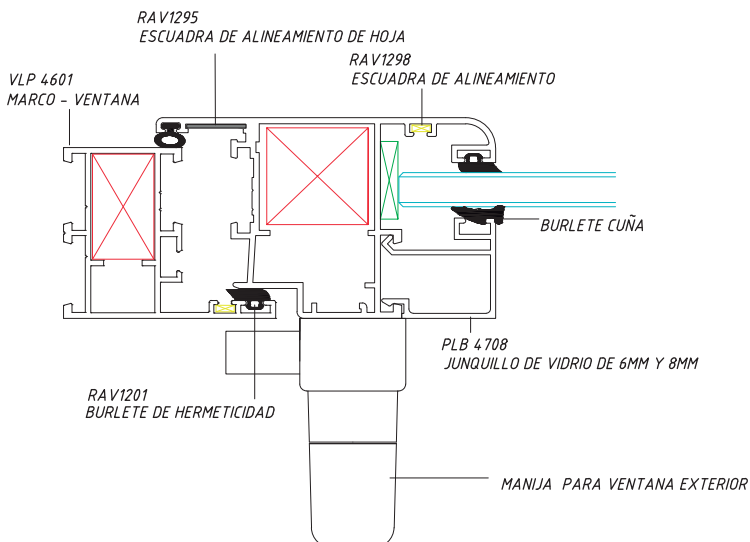



VENTANA BATIENTE EXTERIOR 2 HOJAS

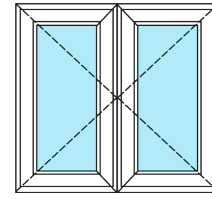

PERFILES

CÓDIGO	PERFIL	UND	TIPO DE CORTE	CANTIDAD
VLP4601	MARCO VENTANA	4	45º	1 PERÍMETRO
VLP4604	HOJA VENTANA APERTURA EXTERIOR PESADA	8	45º	1.5 PERÍMETROS
PLB4708	JUNQUILLO DE VIDRIO DE 6 MM Y 8 MM	8	90º	1.5 PERÍMETROS
VLP4609	INVERSOR	1	90º	1 VERTICAL

ACCESORIOS

ITEM	DESCRIPCIÓN	UND	CANTIDAD
RAV0001239	MANIJA NEGRO PARA PROYECTANTE VLP46 9560/ 1154300210 - MR	UND	1
RAV0001252	MANIJA GRIS PARA PROYECTANTE VLP46 9560/ 1154300208 - MR	UND	
RAV0001268	MANIJA BLANCO PARA PROYECTANTE VLP46 9560/ 1154300200 - MR	UND	
RAV0001237	BISAGRA GRIS PARA VENTANA EXT/INT VLP46 CE 5080 INOX 1106310101 MR	UND	4
RAV0001264	BISAGRA BLANCO PARA VENTANA EXT/INT VLP46 CE 5080 INOX 1106310200 MR	UND	
RAV0001265	BISAGRA NEGRO PARA VENTANA EXT/INT VLP46 CE 5080 INOX 1106310210 MR	UND	
RAV0001205	ESCUADRA 24.5 x 13.80 PARA MARCO Y HOJA DE VLP46	UND	12
RAV0001315	KIT PASADOR PARA VENTANA INT/ EXT 2º HOJA VLP46 PONT.503 1181108100 - MR	PAR	1
RAV0001198	ESCUADRA DE ALINEAMIENTO 5X2X32 PARA SERIE PRACTICABLE	UND	12
RAV0001200	BURLETE EPDM DOBLE CONTACTO 309.R041.02.TP PARA SISTEMA PRACTICABLE (HOJA)	MTS	2 PERÍMETROS
RAV0001201	BURLETE EPDM DE HERMETICIDAD 300.A200.01.EB PARA SISTEMA PRACTICABLE (MARCO Y HOJA)	MTS	4 PERÍMETROS
RAV0001212	TAPA DE NYLON PARA INVERSOR DE SISTEMA PRACTICABLE	UND	1
RAV0001137	CUÑA DE 3 MM PARA VIDRIO DE 8 MM	MTS	2 PERÍMETROS
RAV0001157	CUÑA DE 5 MM PARA VIDRIO DE 6 MM	MTS	2 PERÍMETROS
RAV0001295	ESCUADRA DE ALINEAMIENTO HOJA	UND	8

Matriz

Matriz múltiple
sistema practicable
AP40/LIM



Punzadora Manual

Para Sistema
Practicable
Modelo: C26-1842-
N 18x12
***Solo uso**
en escuadras





CORTE VERTICAL

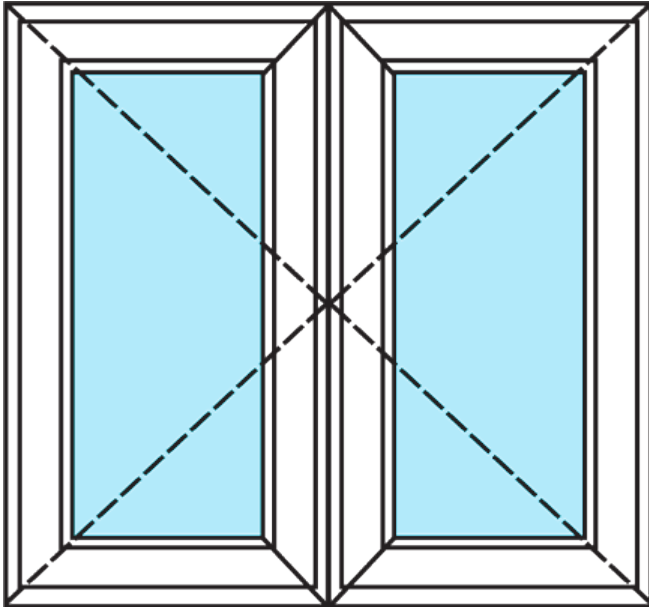

2 HOJAS APERTURA EXTERIOR
VLP46

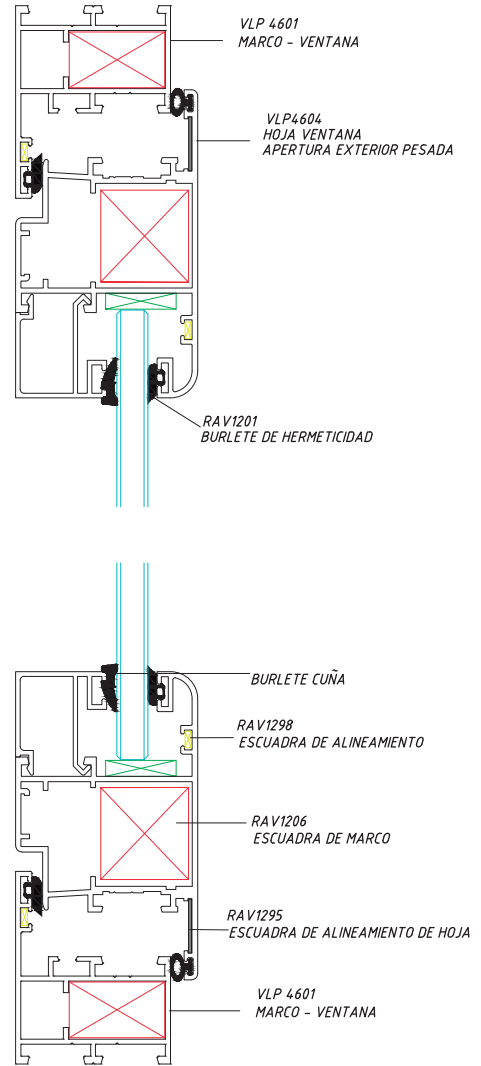

CORTE HORIZONTAL





TABLA DE DESCUENTOS SERIE BATIENTE EXTERIOR PESADA VLP46



1 HOJA

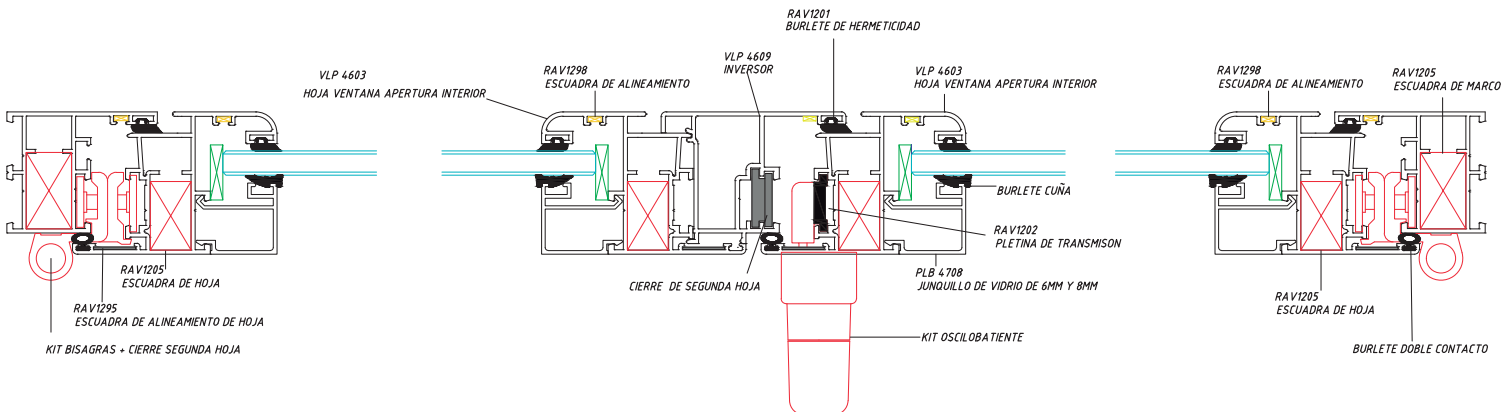
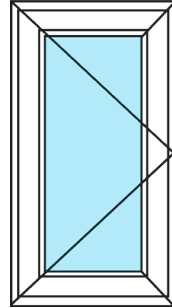
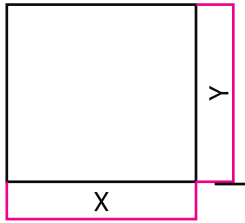
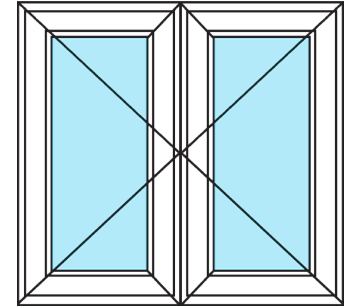

2 HOJAS

PERFIL	FORMULA	CANT	FORMULA	CANT
VLP4601 MARCO HORIZONTAL	X	2	X	2
VLP4601 MARCO VERTICAL	Y	2	Y	2
VLP4604 HOJA HORIZONTAL	X - 46	2	X/2 - 26	4
VLP4604 HOJA VERTICAL	Y - 46	2	Y - 46	4
PLB4708 JUNQUILLO HORIZONTAL	X - 159	2	X/2 - 139	4
PLB4708 JUNQUILLO VERTICAL	Y - 160	2	Y - 160	4
VLP4609 INVERSOR	-	-	Y - 110	1

VIDRIOS

BASE	X - 168	1	X/2 - 150	2
ALTURA	Y - 168		Y - 168	