



CATÁLOGO DE ALUMINIOS

Bienvenido a Corporación Limatambo

¿Quiénes somos?

Corporación Limatambo inicio sus operaciones en los años 90, poniendo a su disposición más de 30 años de experiencia en la comercialización y fabricación de productos de calidad para la Industria del Vidrio.

Buscamos ser un referente en la profesionalización de la Industria, brindando productos de garantía e información para el crecimiento profesional de nuestros clientes.

Estamos comprometidos con el desarrollo de “La Industria del Vidrio”, por lo cual nos encontramos en constante innovación para satisfacer las constantes necesidades de nuestros clientes.

Contamos con 4 líneas de negocio, que abarcan una gran variedad de productos y servicios al alcance de nuestros clientes.

- Distribución Mayorista a nivel nacional.
- Distribución Minorista por mostrador.
- Cristales templados.
- Servicios generales para el vidrio.
- Proyectos.

“Los Profesionales de la Industria del Vidrio”

Misión

Nuestra misión es brindar alternativas de solución de acuerdo a las exigencias de nuestros clientes, a través de nuestra amplia gama de productos en vidrios, aluminios y bienes afines a la construcción y decoración; garantizando la inversión de nuestros usuarios con el apoyo de nuestros colaboradores calificados y comprometido con su trabajo.

Visión

“Ser líderes en todo el Perú, logrando tener una alta presencia en las distintas obras arquitectónicas y proyectos mediante nuestra amplia gama de productos y servicio de alta calidad”

PERFILES DE ALUMINIO

CONTENIDO

ÁNGULOS IGUALES	3
ÁNGULOS DESIGUALES	5
CANALES	6
PLATINAS	12
TEES	14
BARRAS SÓLIDAS	15
TUBOS CUADRADOS	16
TUBOS RECTANGULARES	19
TUBOS REDONDOS Y OVALADOS	28
BARANDAS	31
CANTONERAS Y TERRAZOS	33
ENCHAPES	35

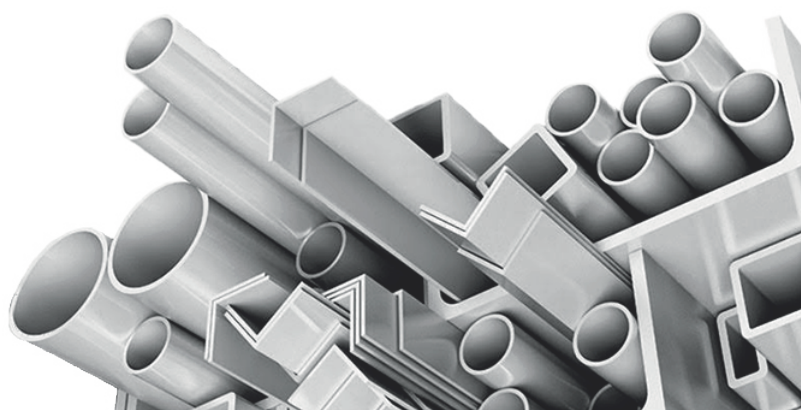

PERFILES DE ALUMINIO

CONTENIDO

ZÓCALOS PARA PISOS	36
FILETES Y TAPAJUNTAS	37
PERFILES Y CELOSÍAS	38
AVISO LUMINOSO Y VITROVEN	40
PERFILES PARA VITRINAS	41
PERFILES PARA HOJA CORREDIZA	43
PERFILES PARA VENTANAS, PUERTAS Y MAMPARAS	44
PERFILES PARA PUERTAS DE DUCHA	57
PERFILES PARA CERÁMICOS, PORCELANATOS Y MUEBLES	60
PERFILES PARA MUEBLES	61
PERFILES PARA CORTINA Y PARA ACCESORIOS DE PUERTAS Y VENTANAS	64
MOLDURAS DECORATIVAS	65





4001

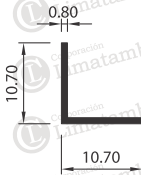

4103

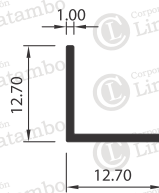

4104

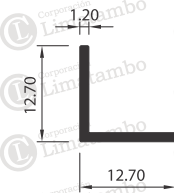

4106

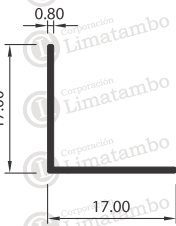

4107

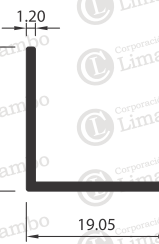

4108

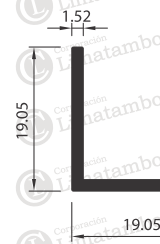

4109

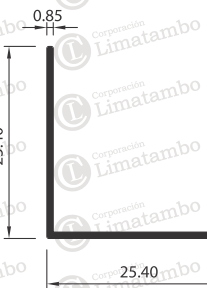

4110

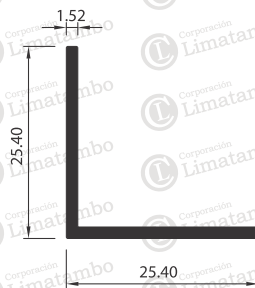

4310

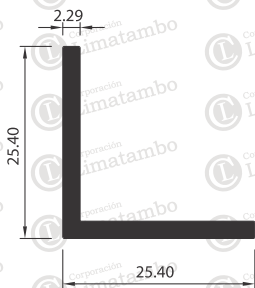

CATÁLOGO DE ALUMINIOS

Medidas en mm/ Escala aproximada 1/1
Espesores con tolerancia ± 0.13 mm. aprox.

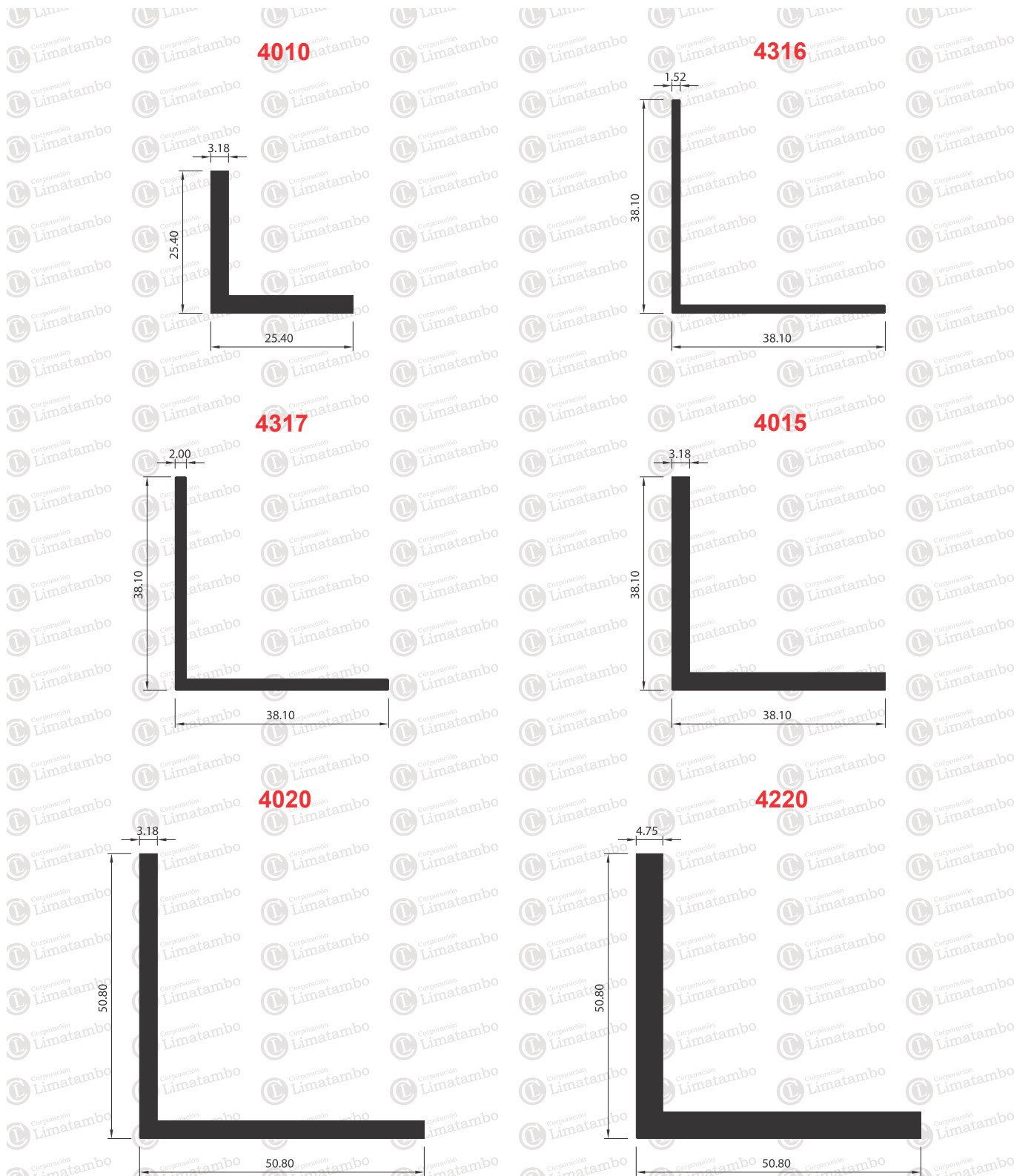

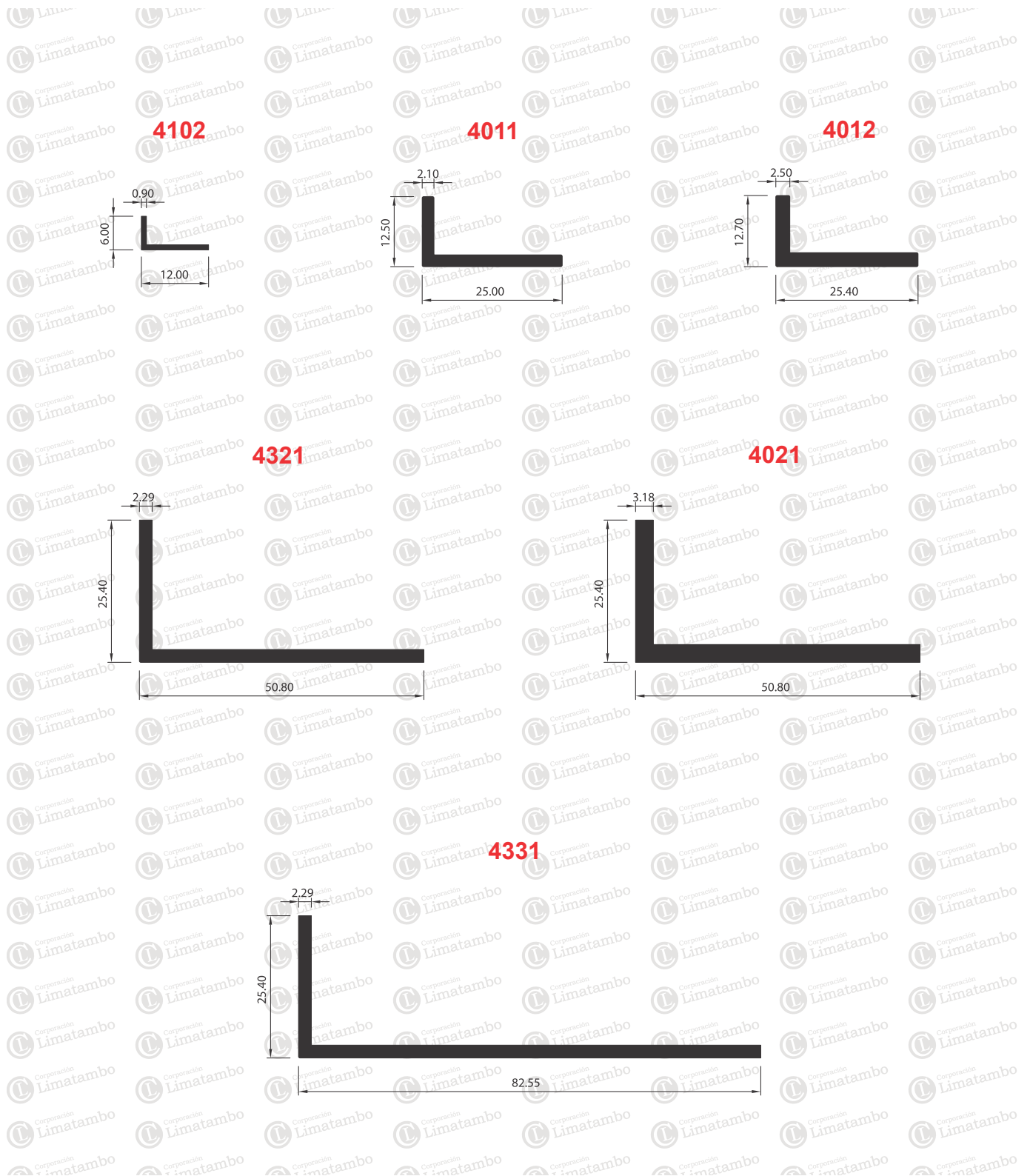

CATÁLOGO DE ALUMINIOS

Medidas en mm/ Escala aproximada 1/1

Espesores con tolerancia ± 0.13 mm. aprox.

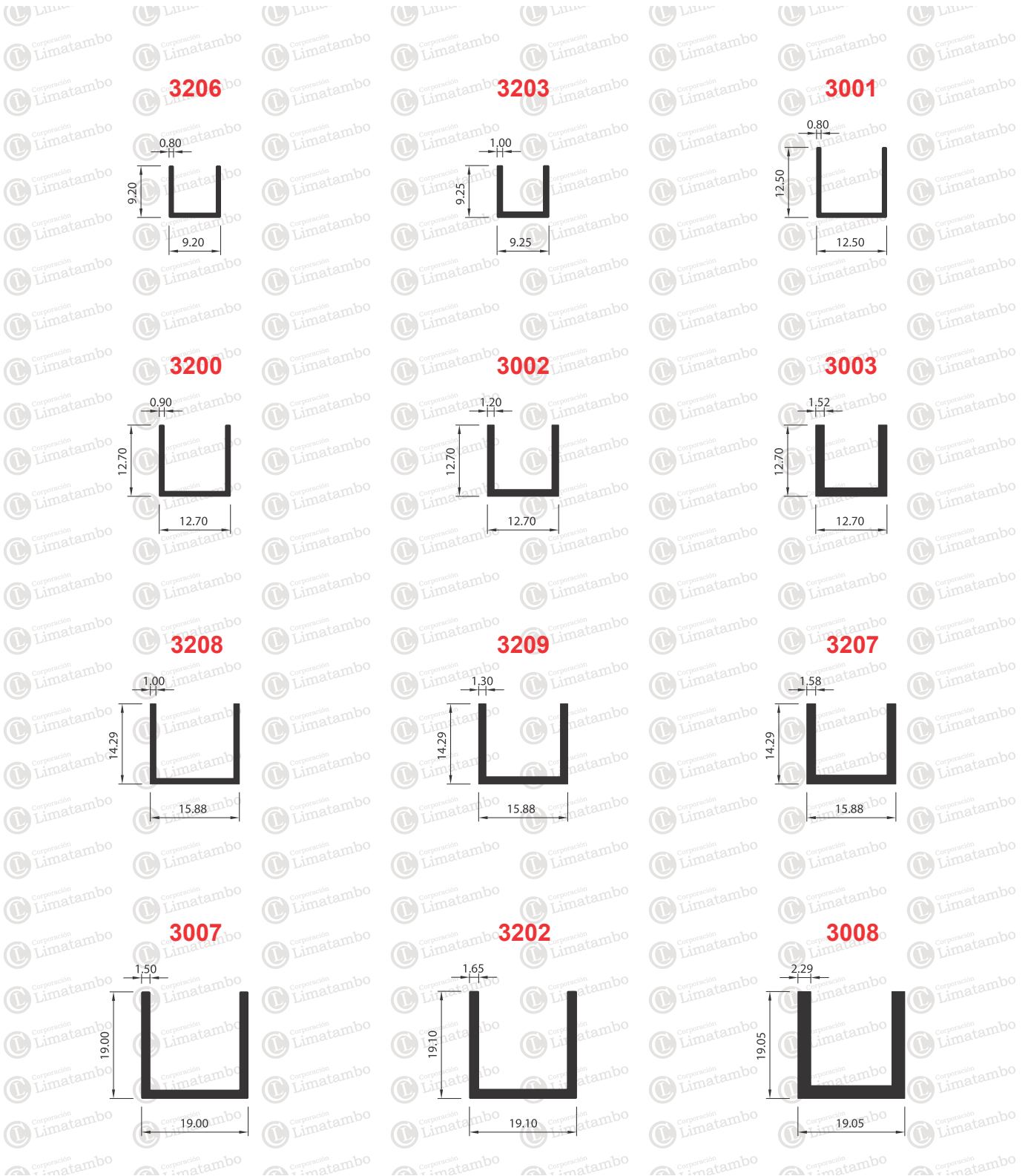



7954

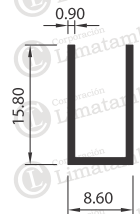

7955



7956

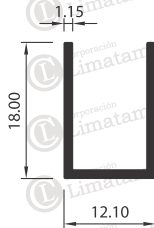

3009



3012



3011



3031

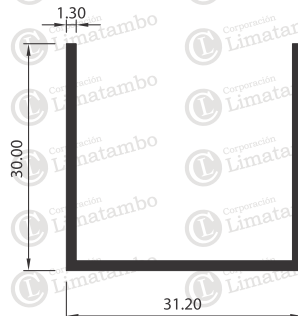

CATÁLOGO DE ALUMINIOS

Medidas en mm/ Escala aproximada 1/1
Espesores con tolerancia ± 0.13 mm. aprox.

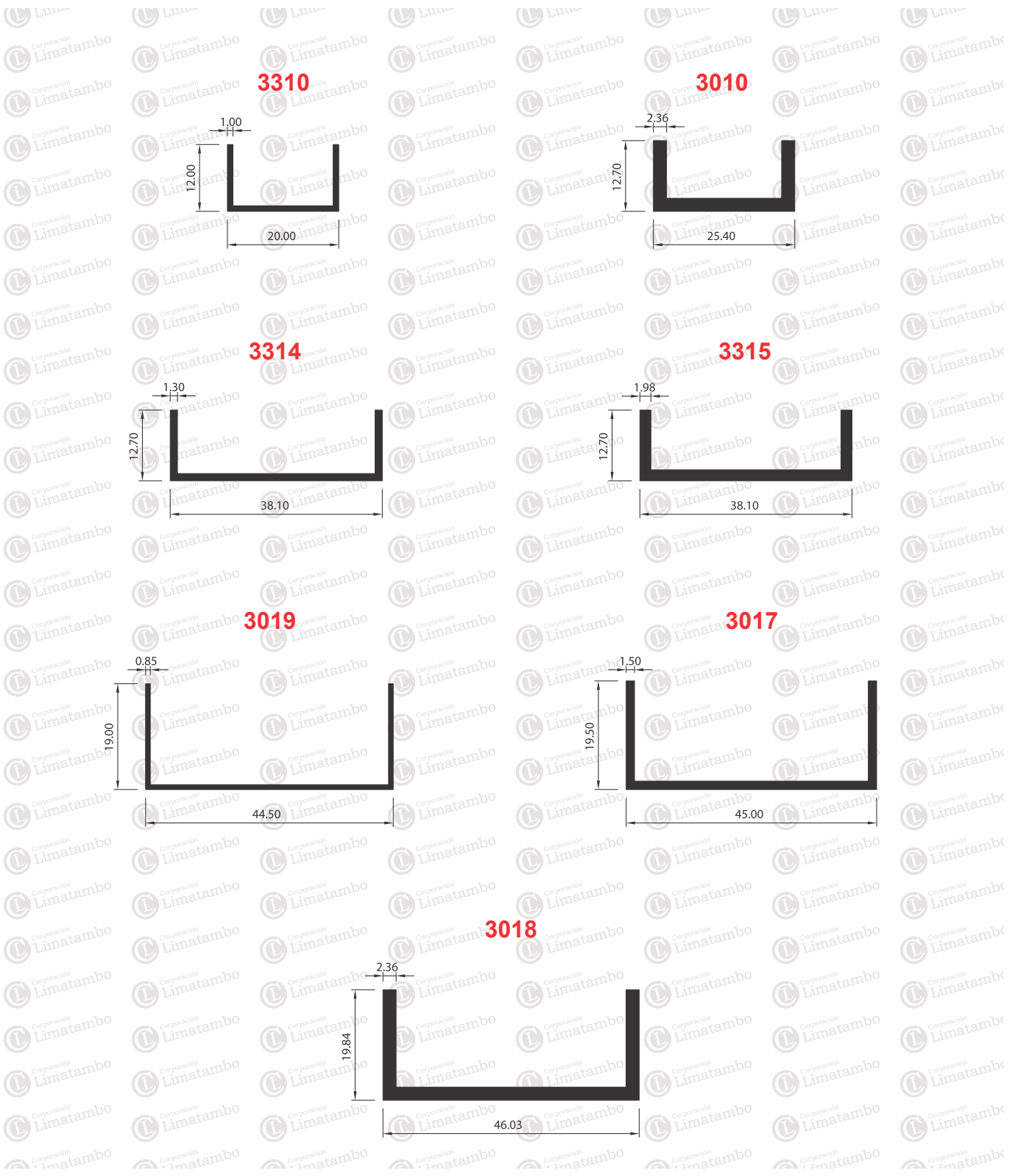

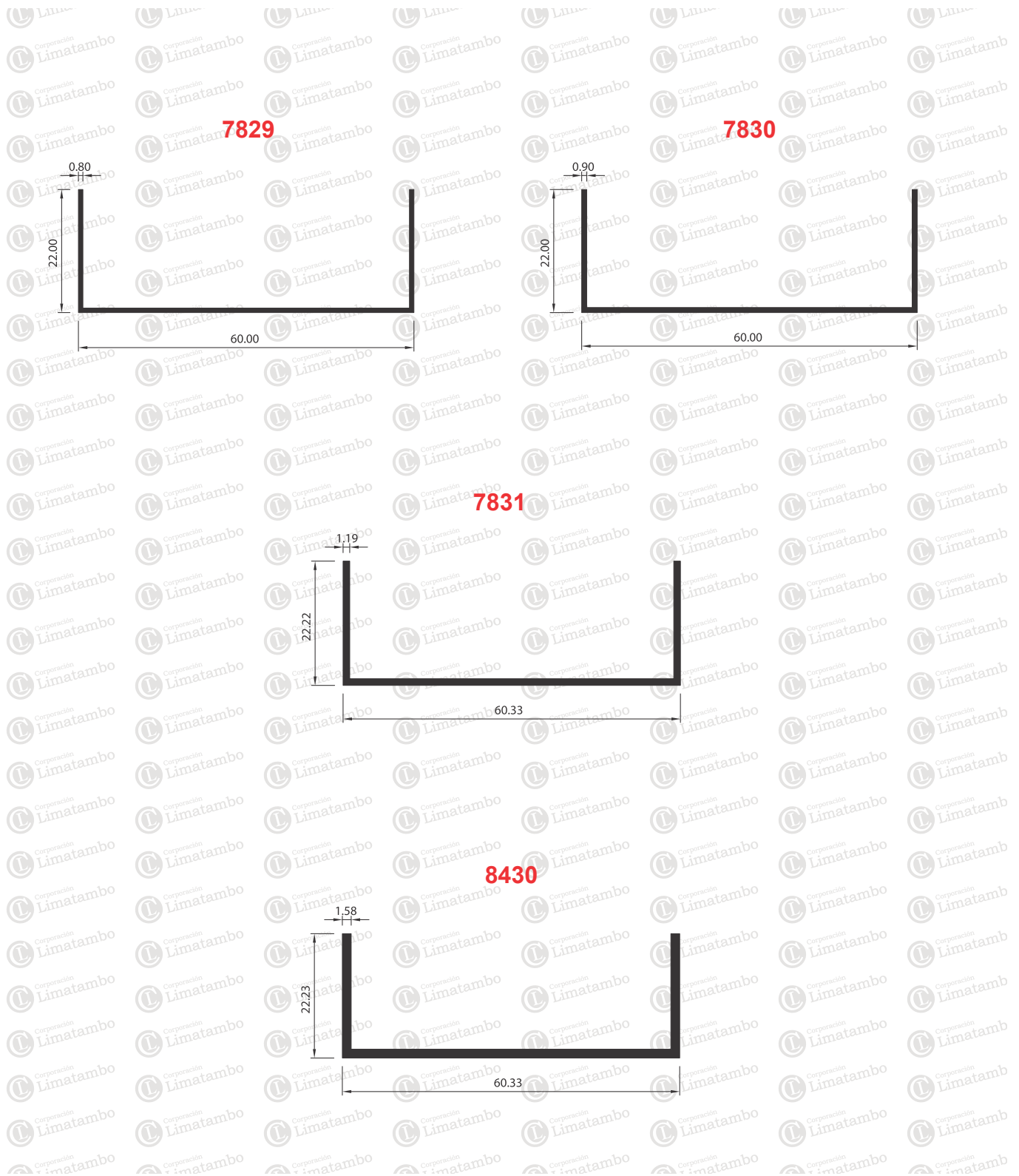

CATÁLOGO DE ALUMINIOS

Medidas en mm/ Escala aproximada 1/1
Espesores con tolerancia ± 0.13 mm. aprox.

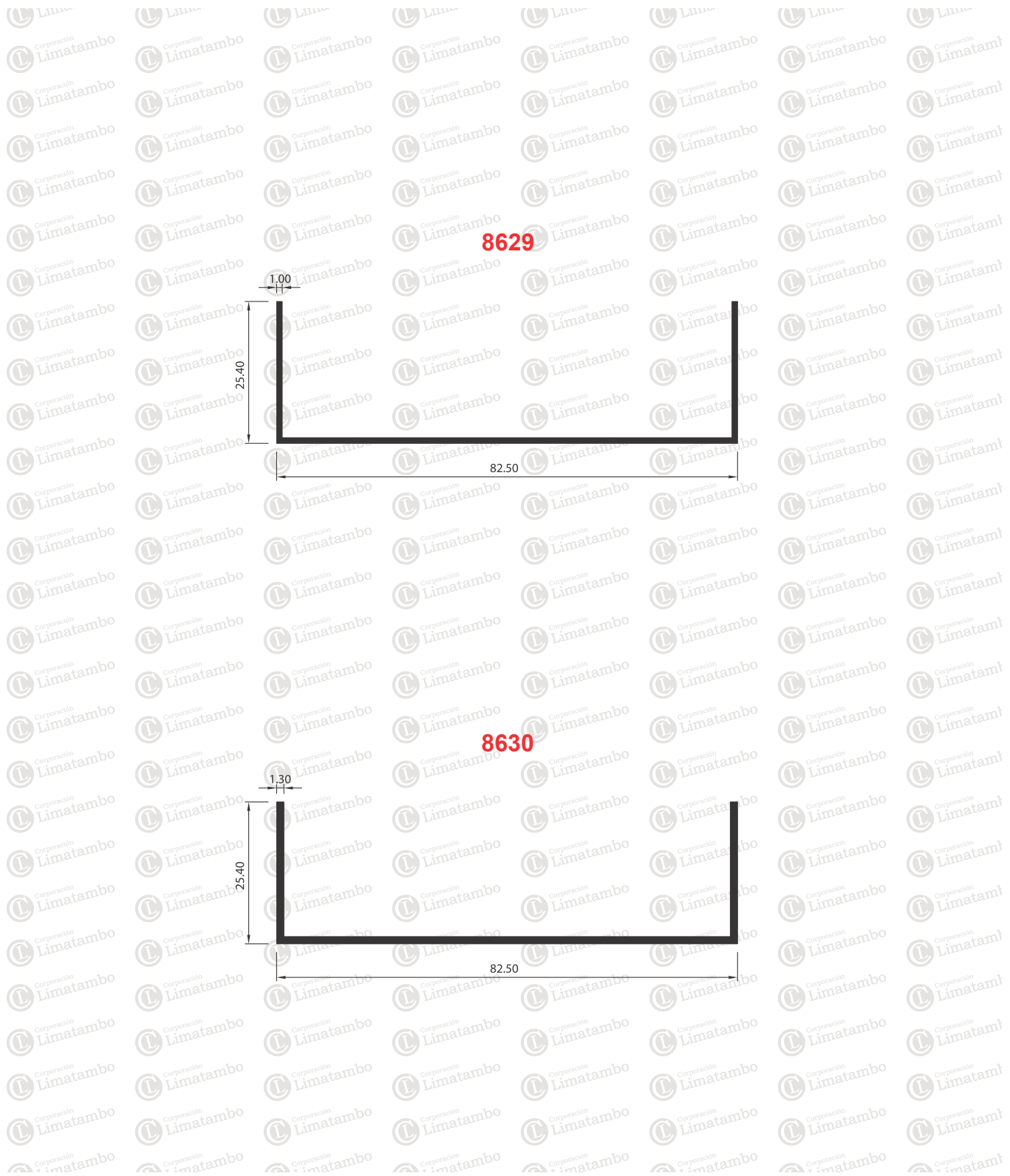

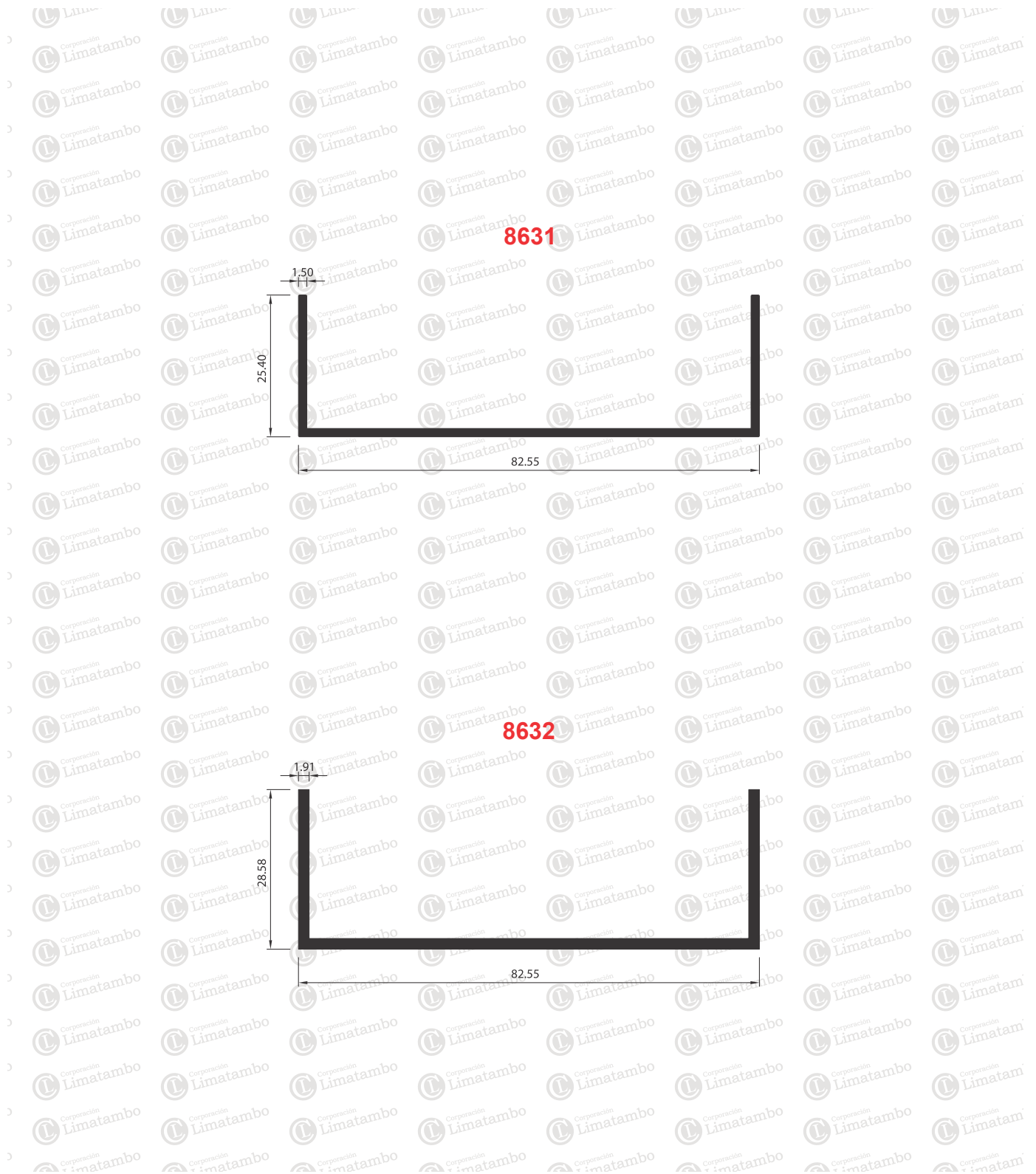

CATÁLOGO DE ALUMINIOS

Medidas en mm/ Escala aproximada 1/1
Espesores con tolerancia ± 0.13 mm. aprox.

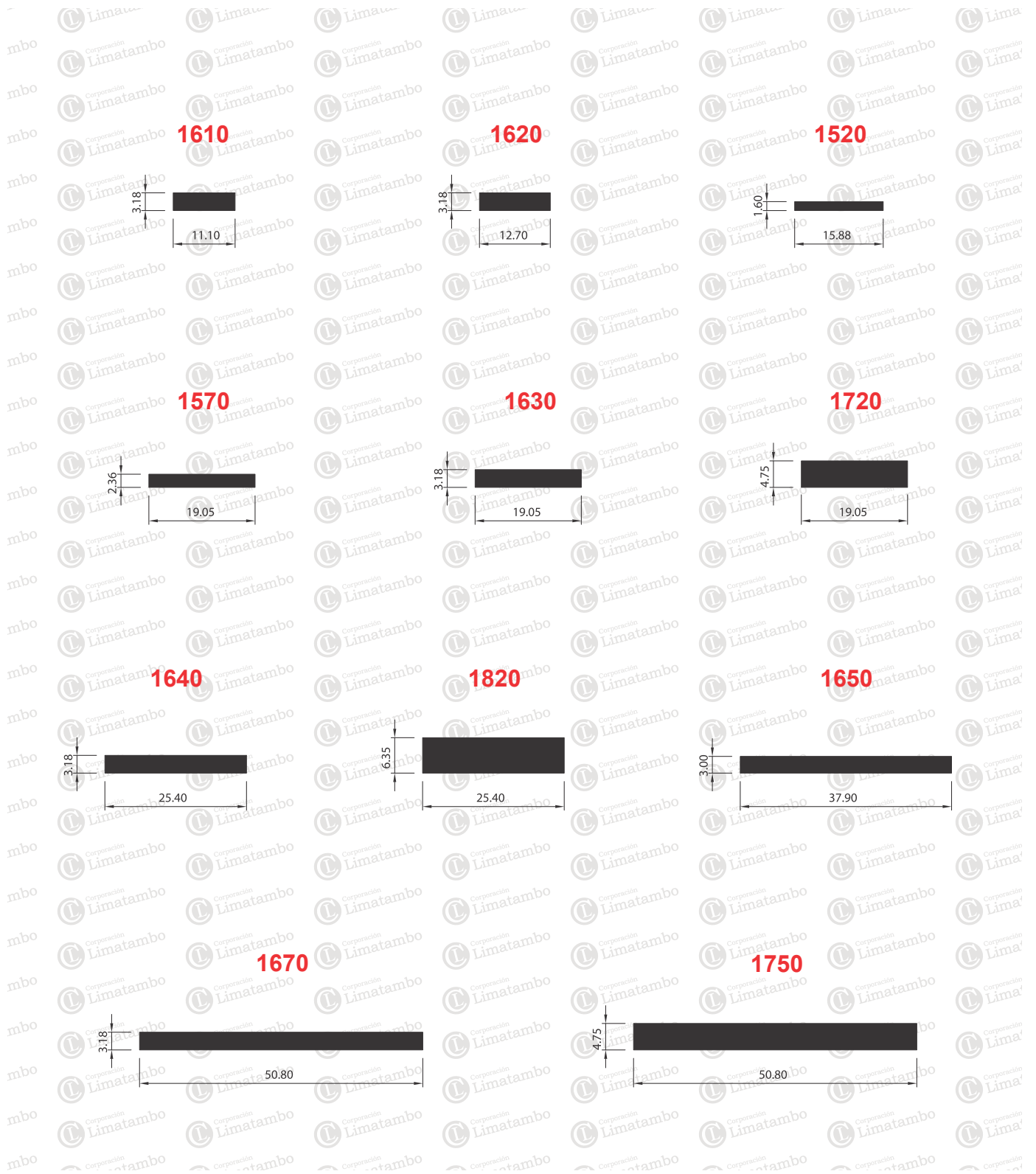

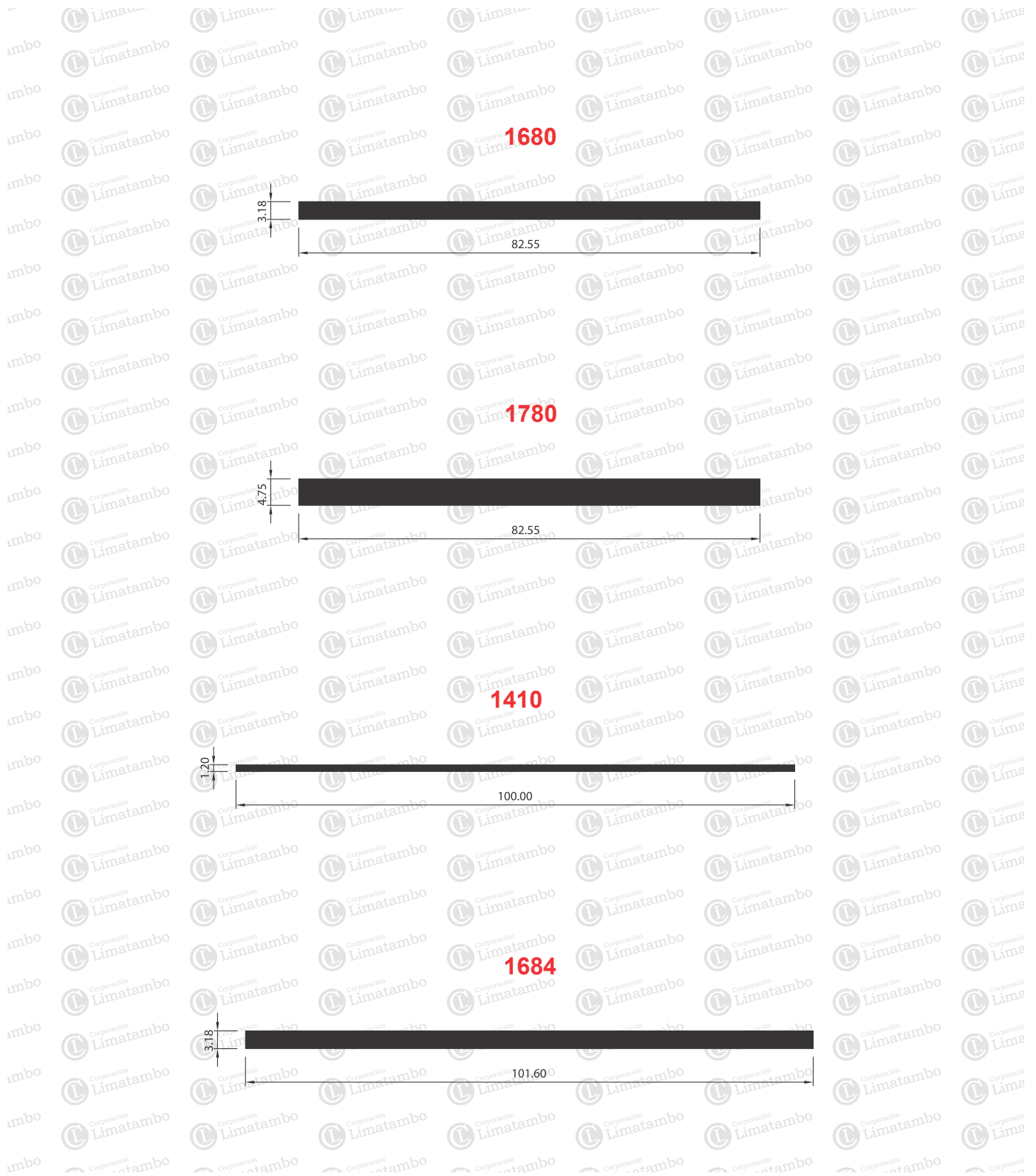

CATÁLOGO DE ALUMINIOS

Medidas en mm/ Escala aproximada 1/1
Espesores con tolerancia ± 0.13 mm. aprox.

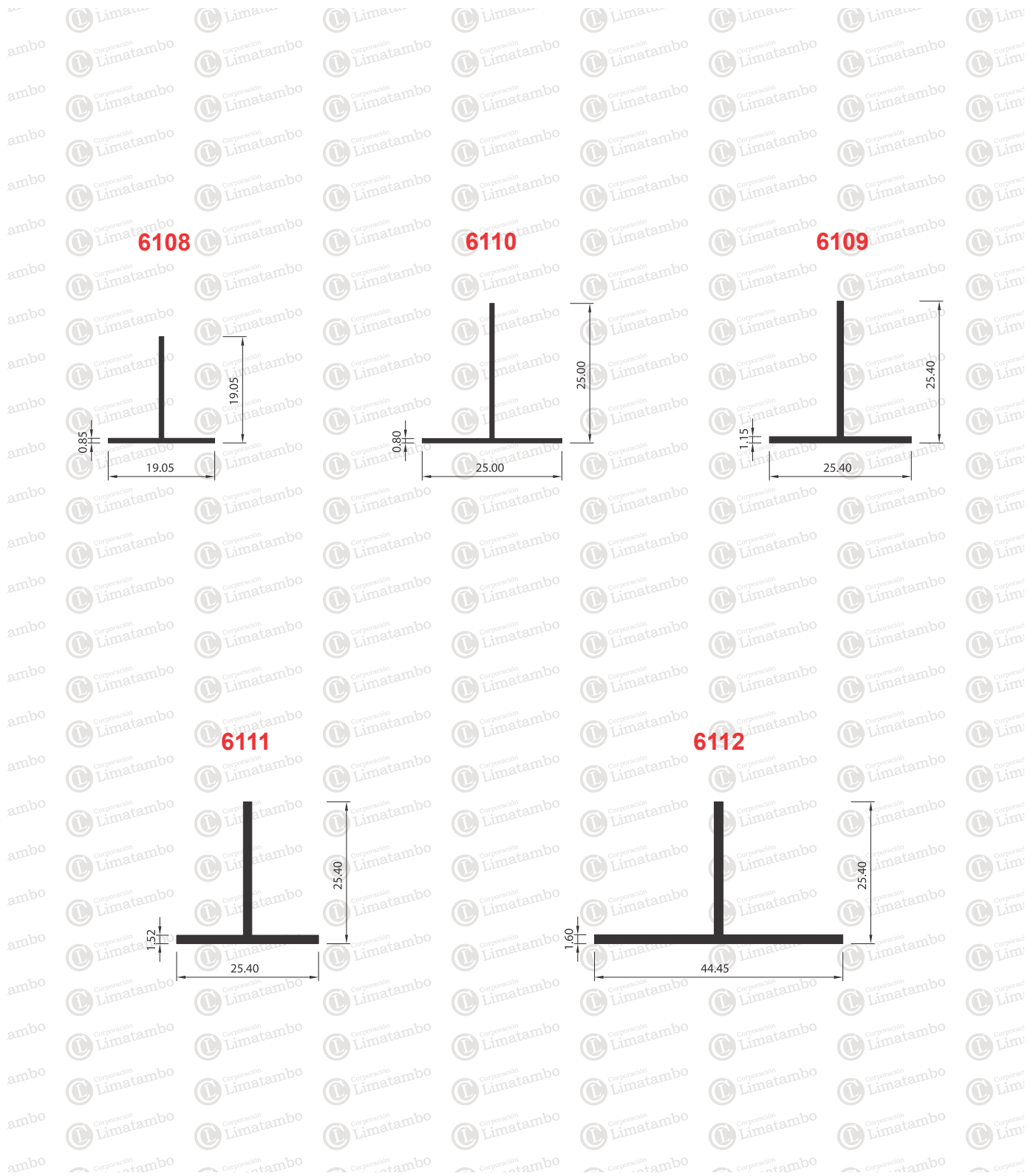

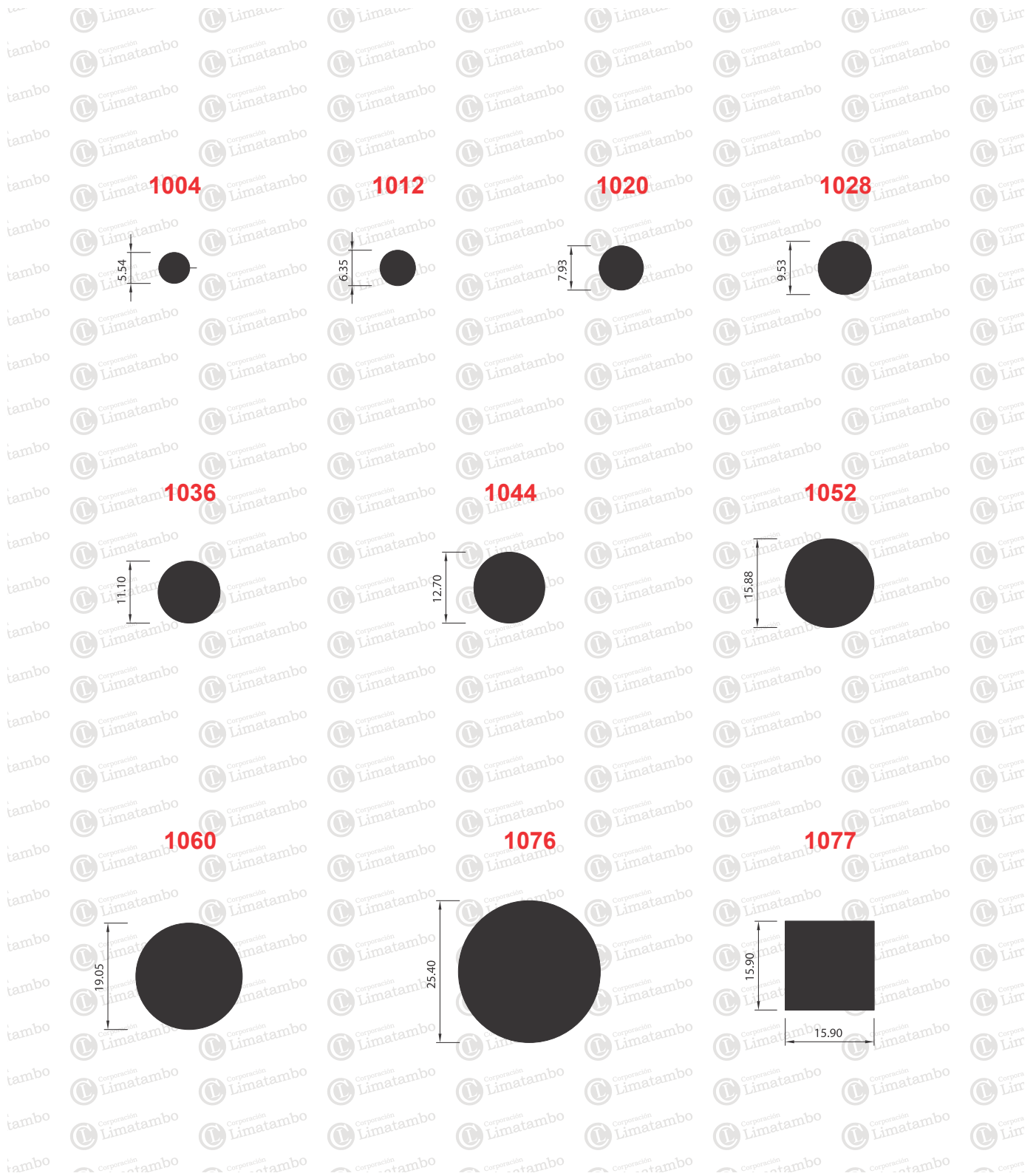

CATÁLOGO DE ALUMINIOS

Medidas en mm/ Escala aproximada 1/1
Espesores con tolerancia ± 0.13 mm. aprox.

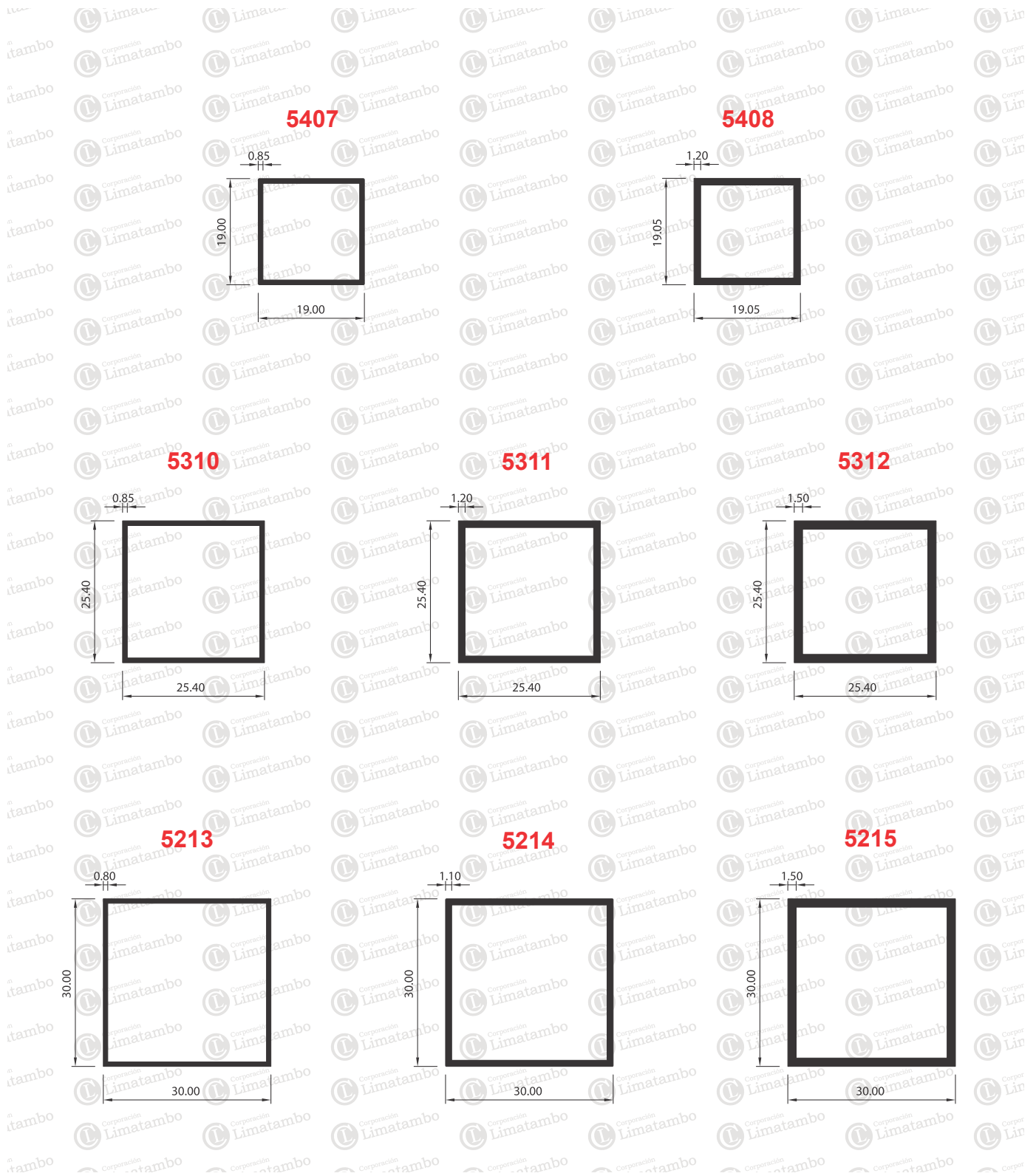

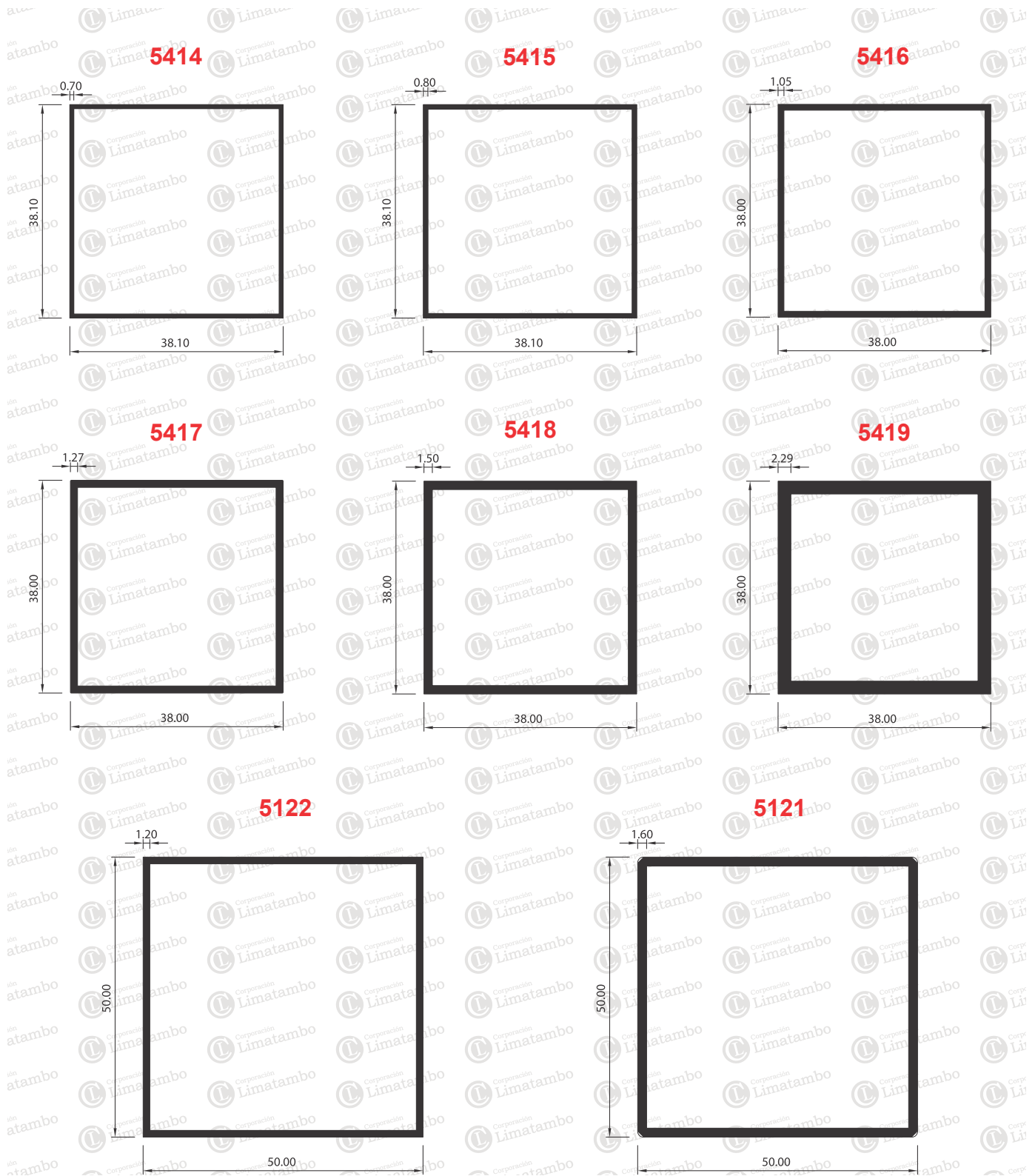

CATÁLOGO DE ALUMINIOS

Medidas en mm/ Escala aproximada 1/1
Espesores con tolerancia ± 0.13 mm. aprox.

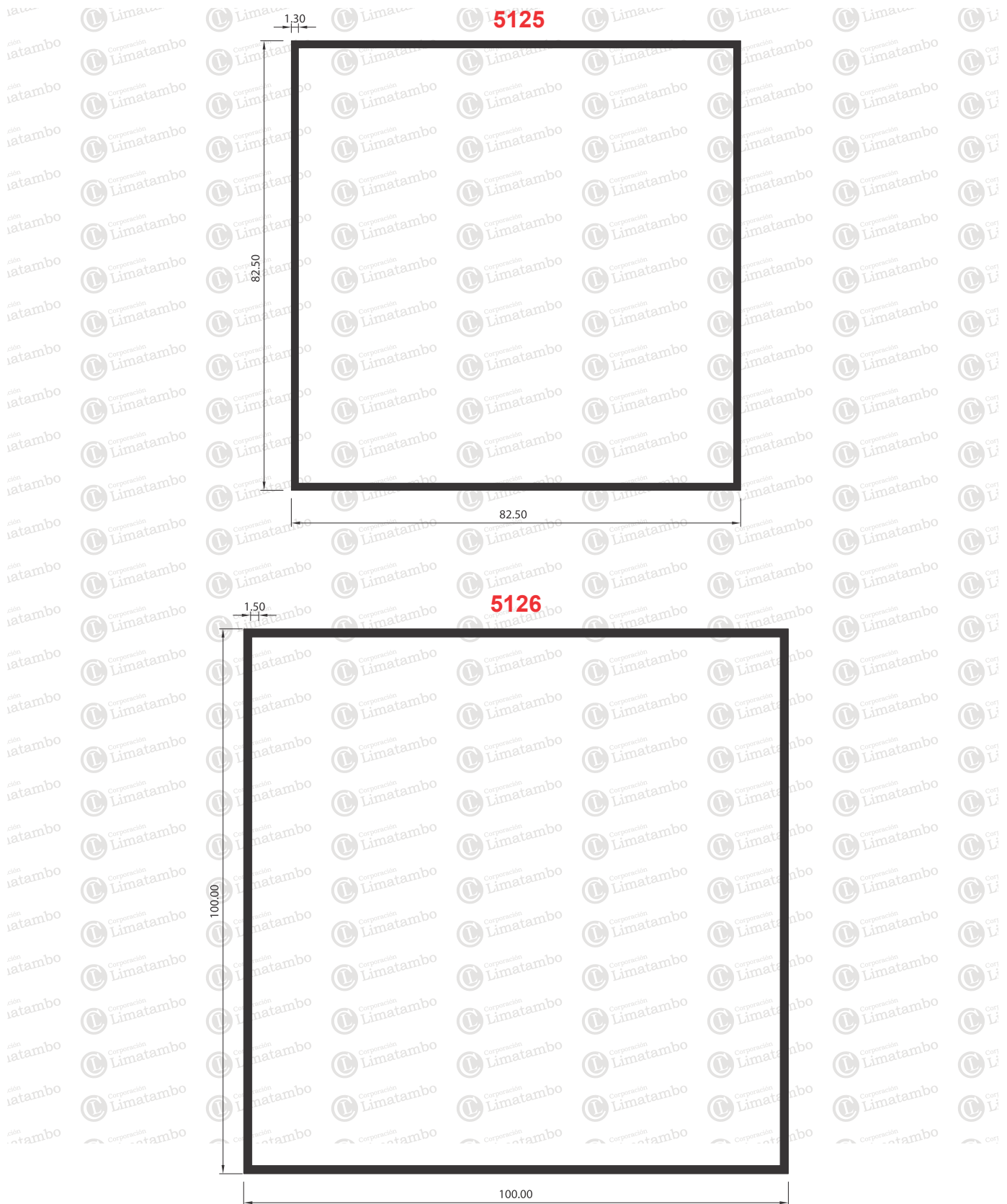

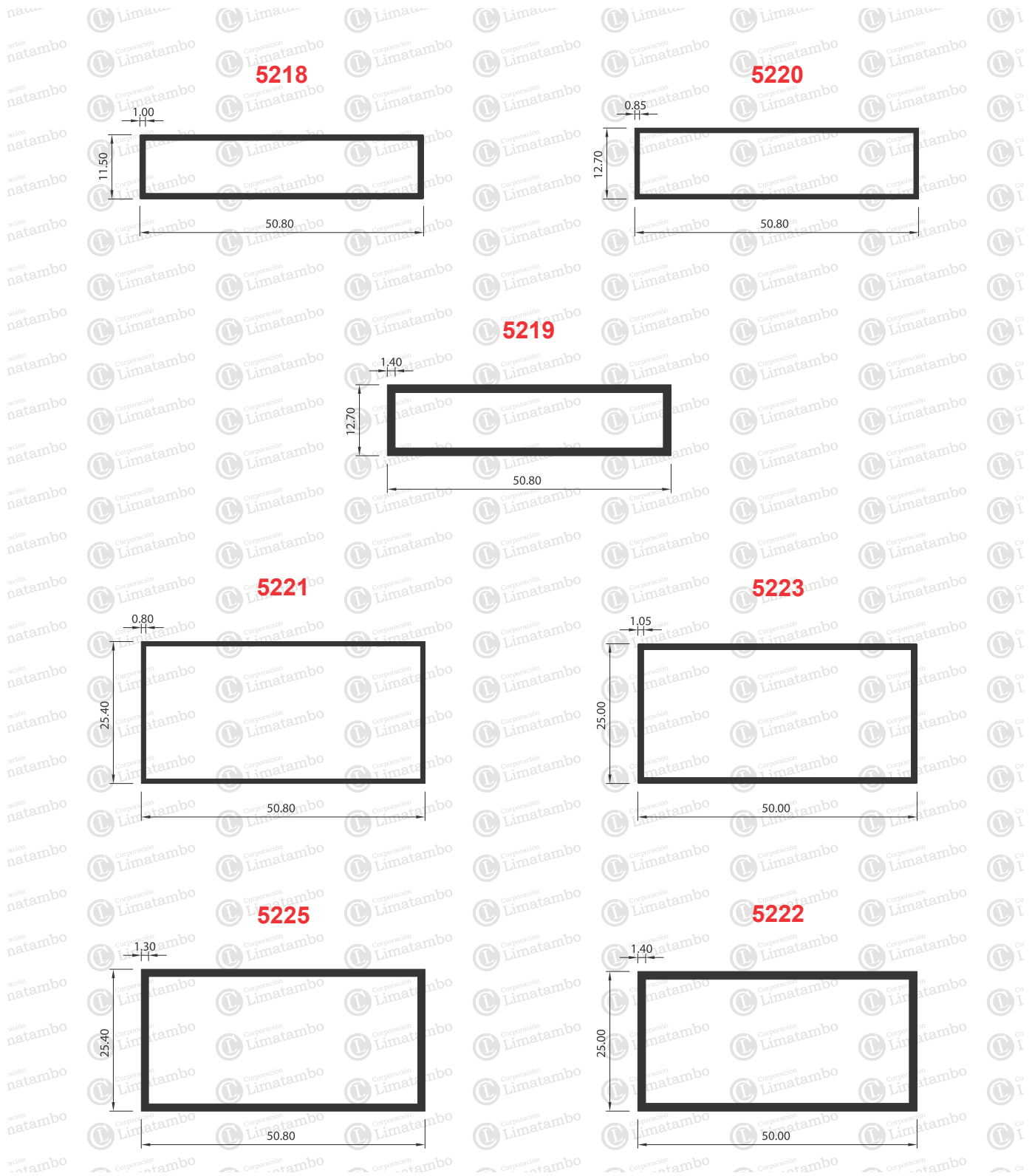

CATÁLOGO DE ALUMINIOS

Medidas en mm/ Escala aproximada 1/1
Espesores con tolerancia ± 0.13 mm. aprox.

5118

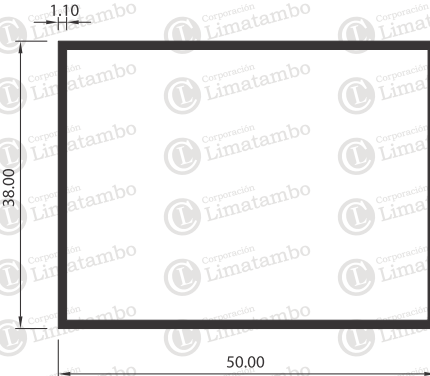

5123

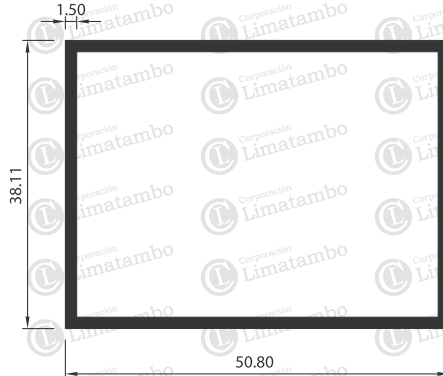

7851



7852



7853



5224



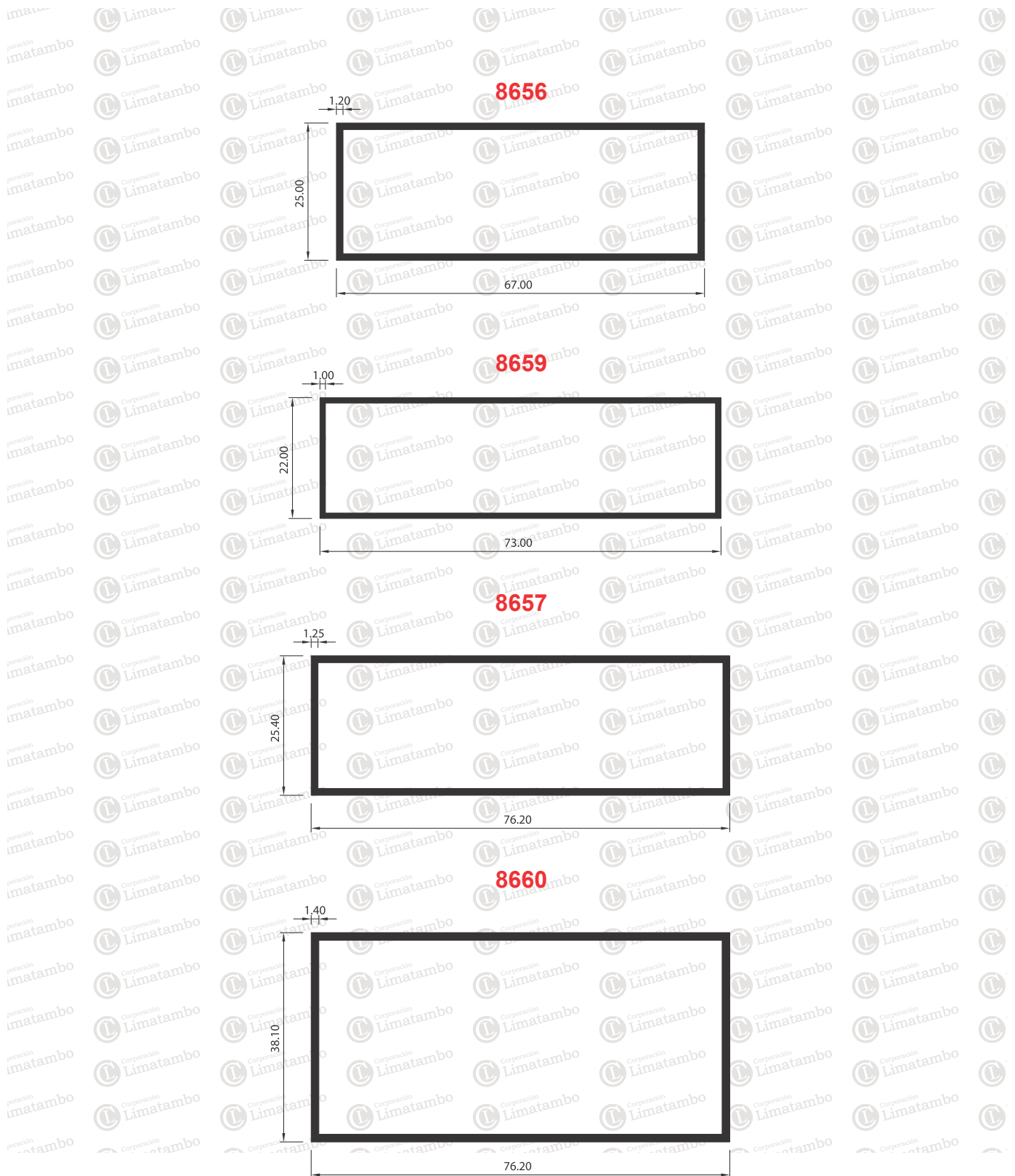

CATÁLOGO DE ALUMINIOS

Medidas en mm/ Escala aproximada 1/1
Espesores con tolerancia ± 0.13 mm. aprox.

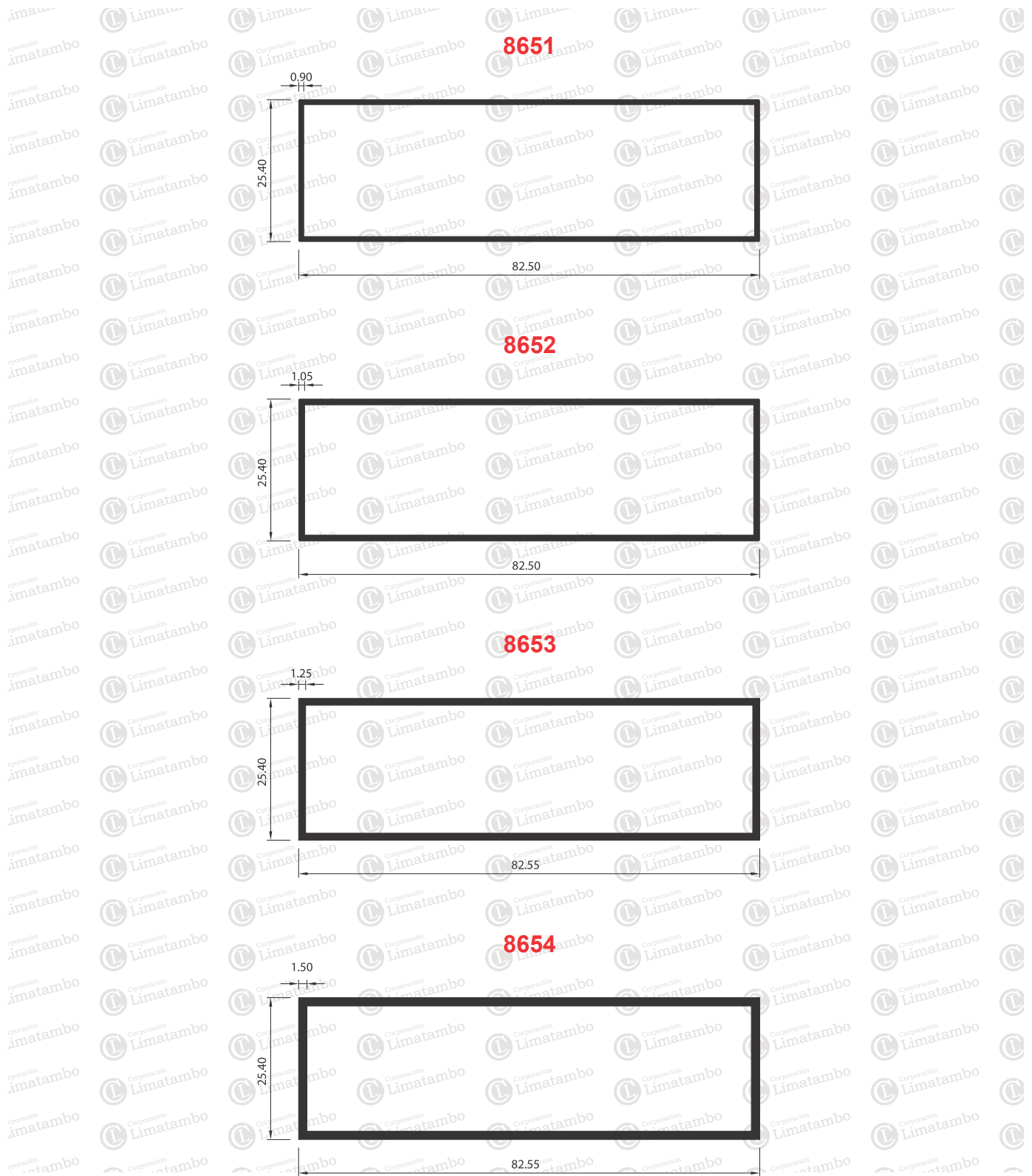

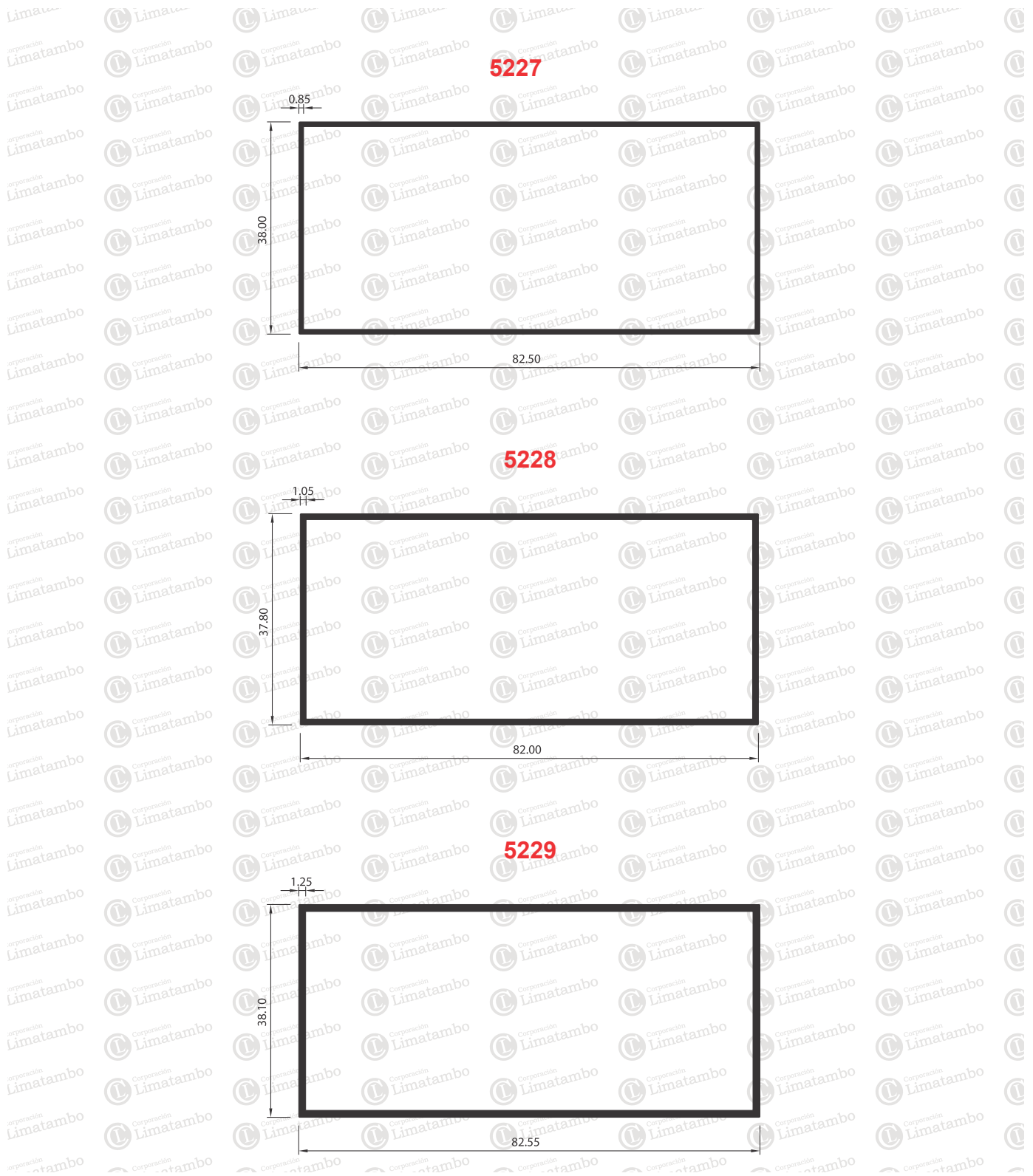

CATÁLOGO DE ALUMINIOS

Medidas en mm/ Escala aproximada 1/1
Espesores con tolerancia ± 0.13 mm. aprox.

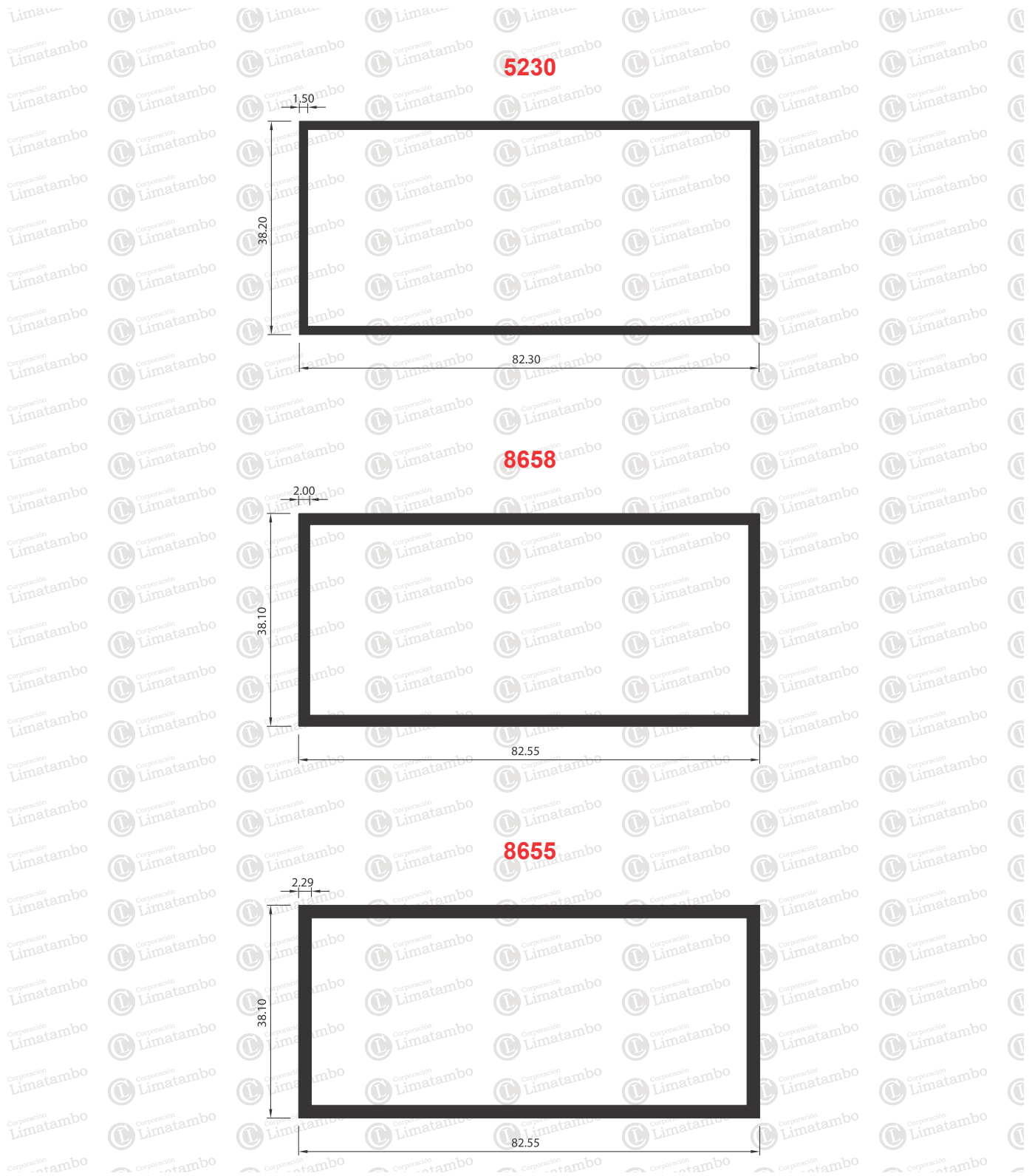

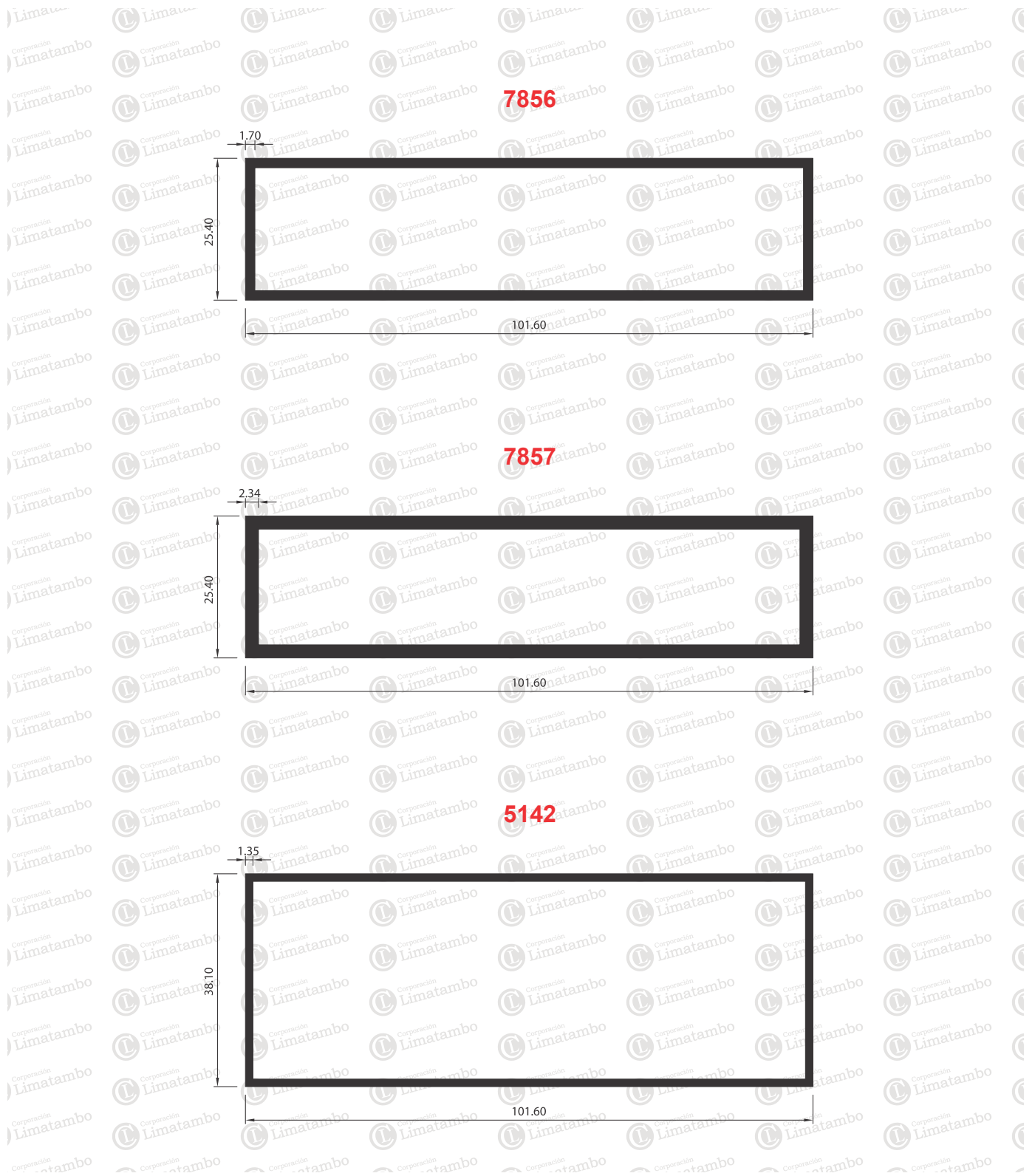

CATÁLOGO DE ALUMINIOS

Medidas en mm/ Escala aproximada 1/1
Espesores con tolerancia ± 0.13 mm. aprox.

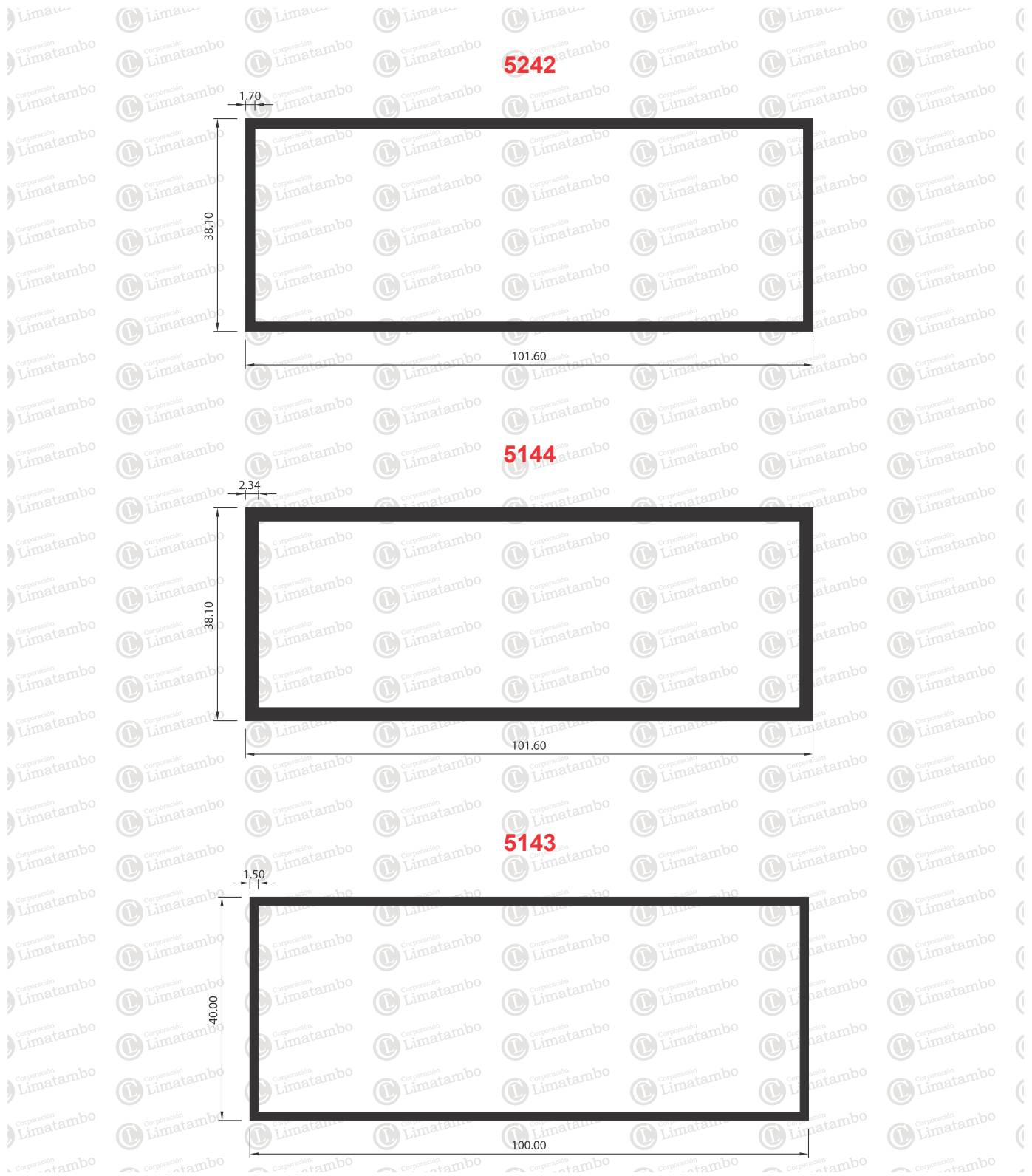

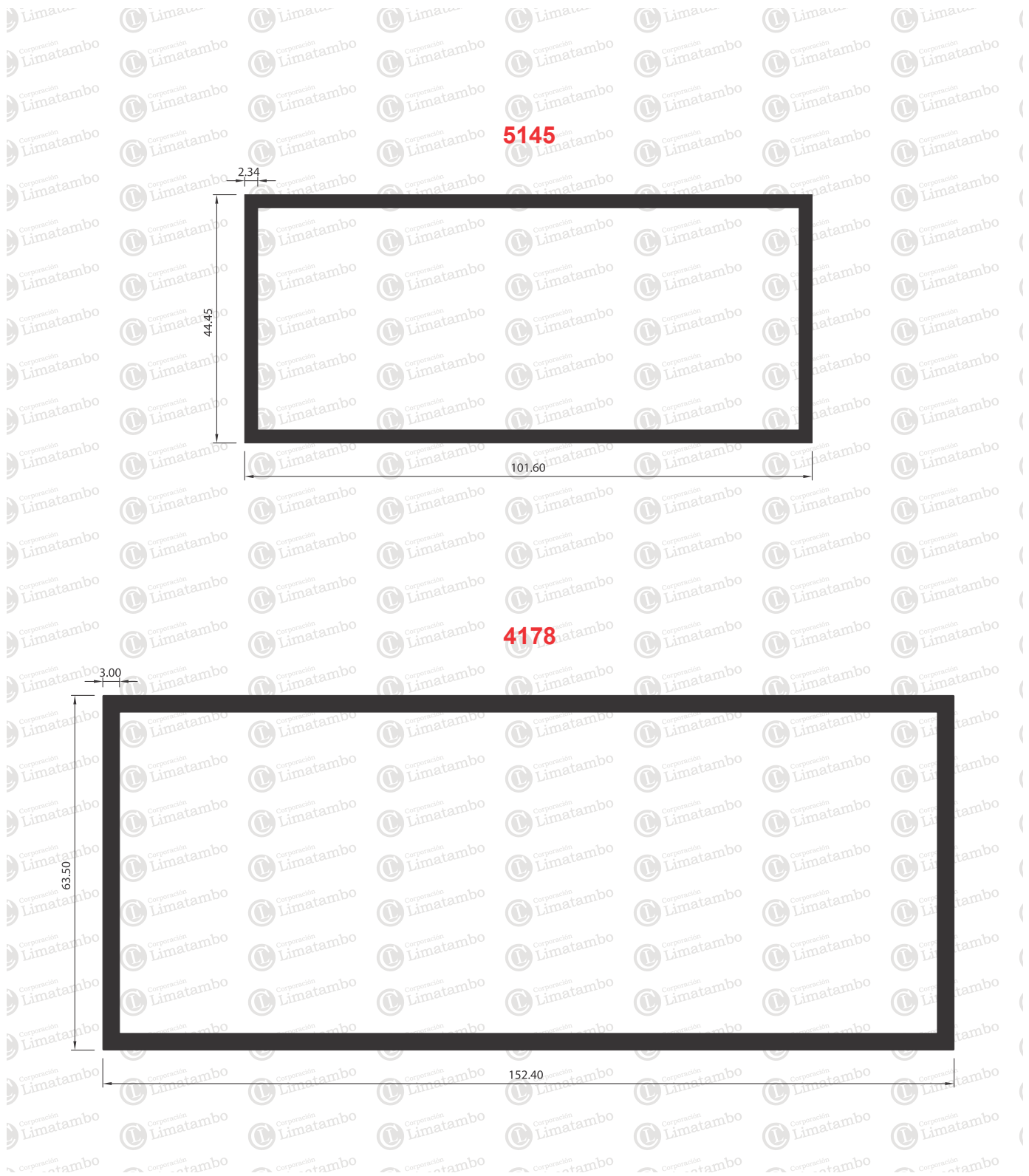

CATÁLOGO DE ALUMINIOS

Medidas en mm/ Escala aproximada 1/1
Espesores con tolerancia ± 0.13 mm. aprox.

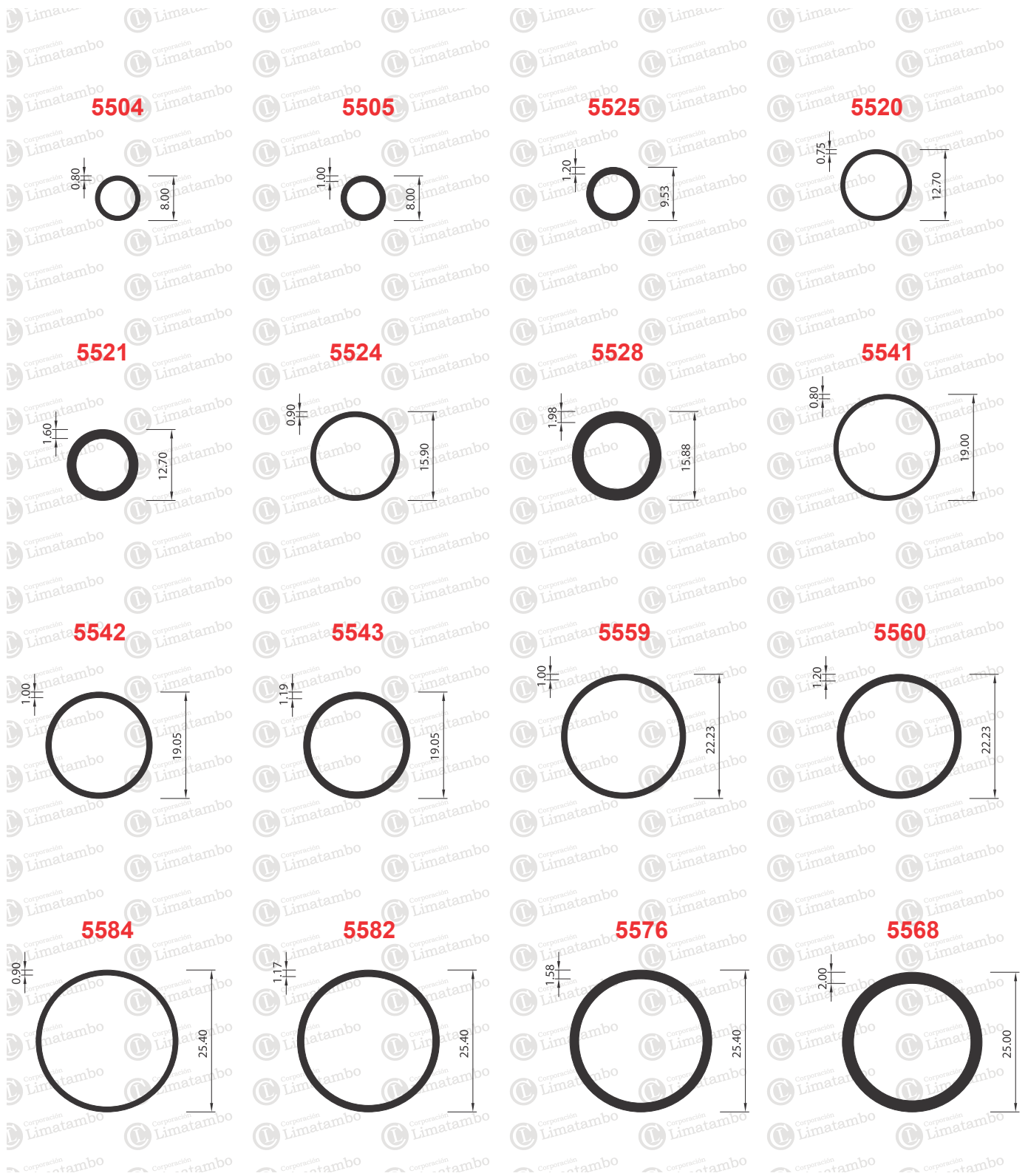

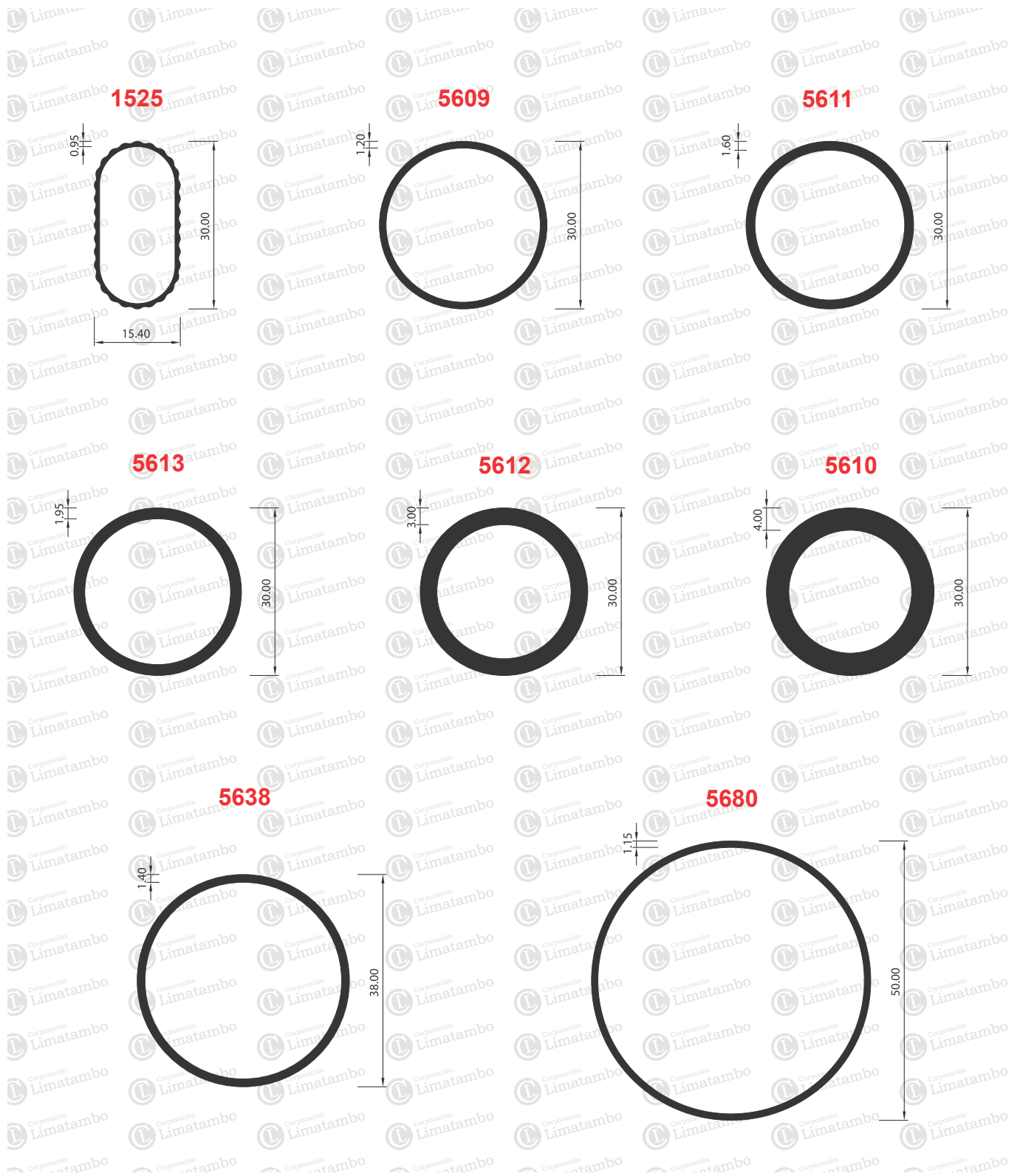

CATÁLOGO DE ALUMINIOS

Medidas en mm/ Escala aproximada 1/1
Espesores con tolerancia ± 0.13 mm. aprox.

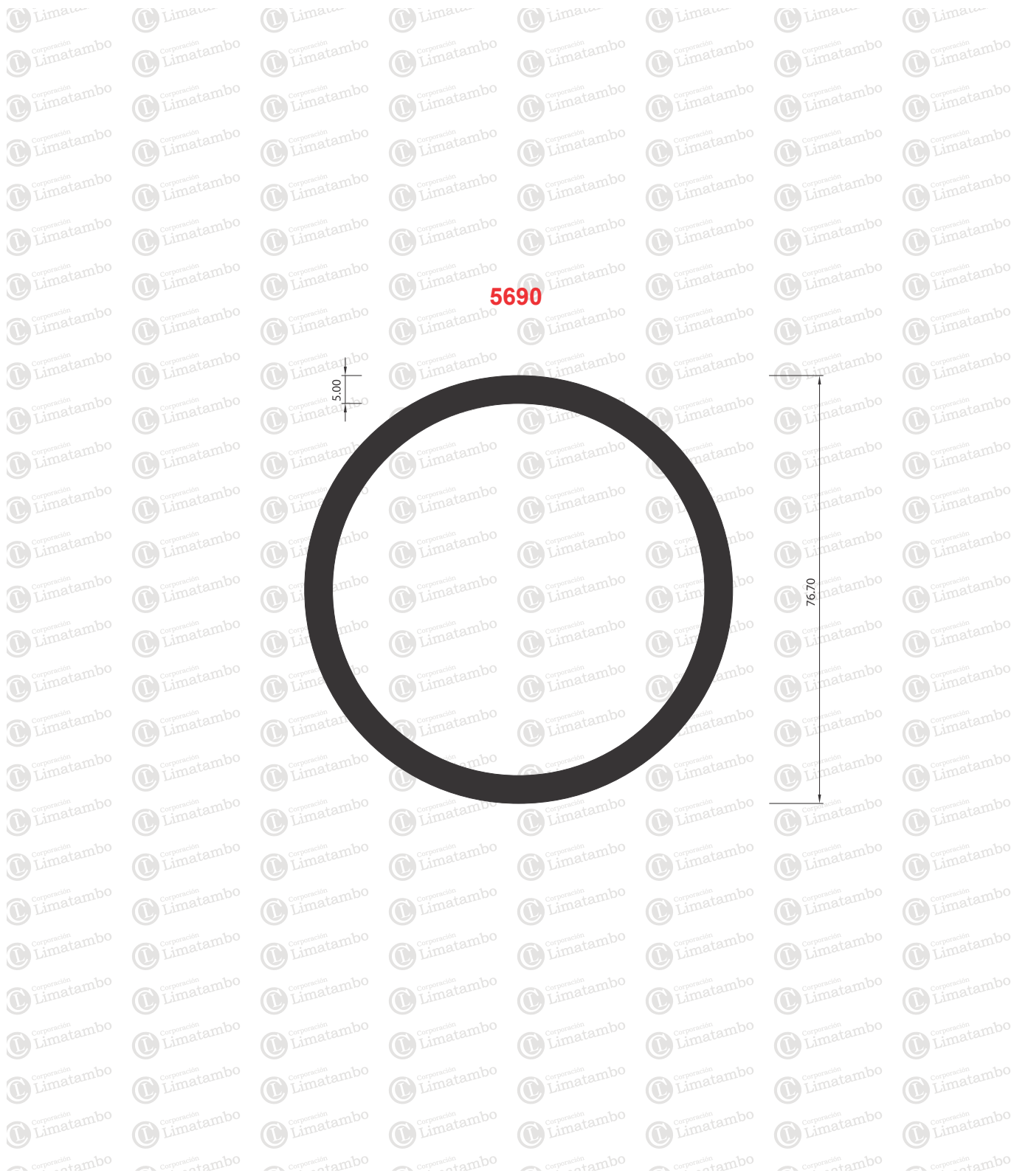



2431

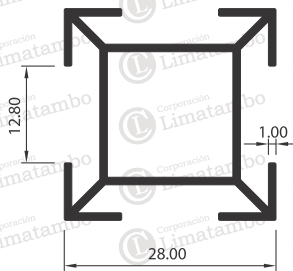

2433

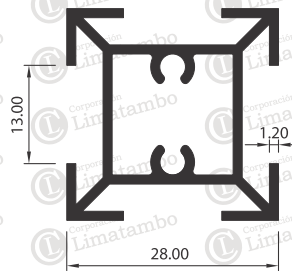

2432

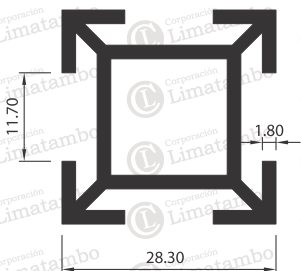

2430

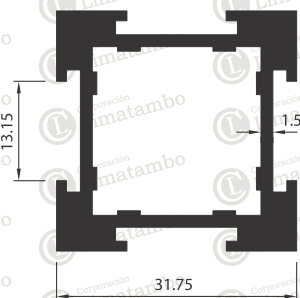

CATÁLOGO DE ALUMINIOS

Medidas en mm/ Escala aproximada 1/1
Espesores con tolerancia ± 0.13 mm. aprox.



2410

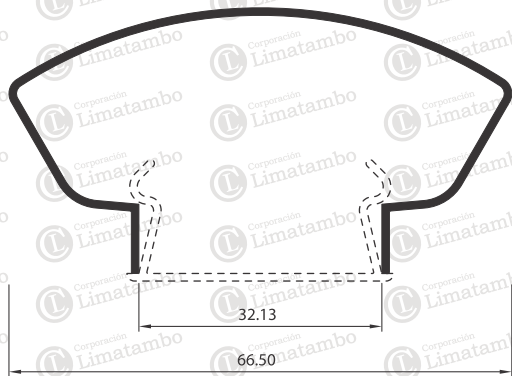

2490

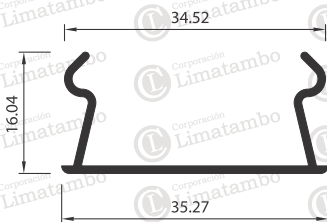

2411

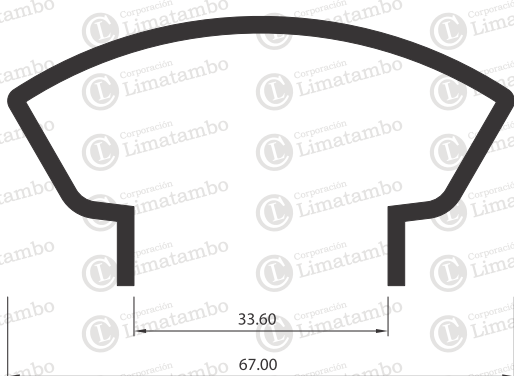

2602

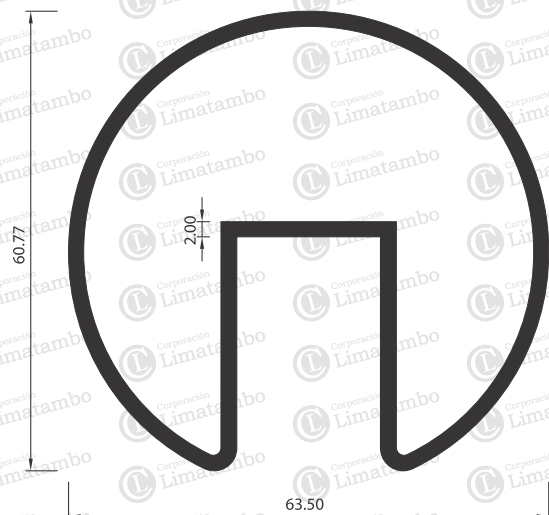

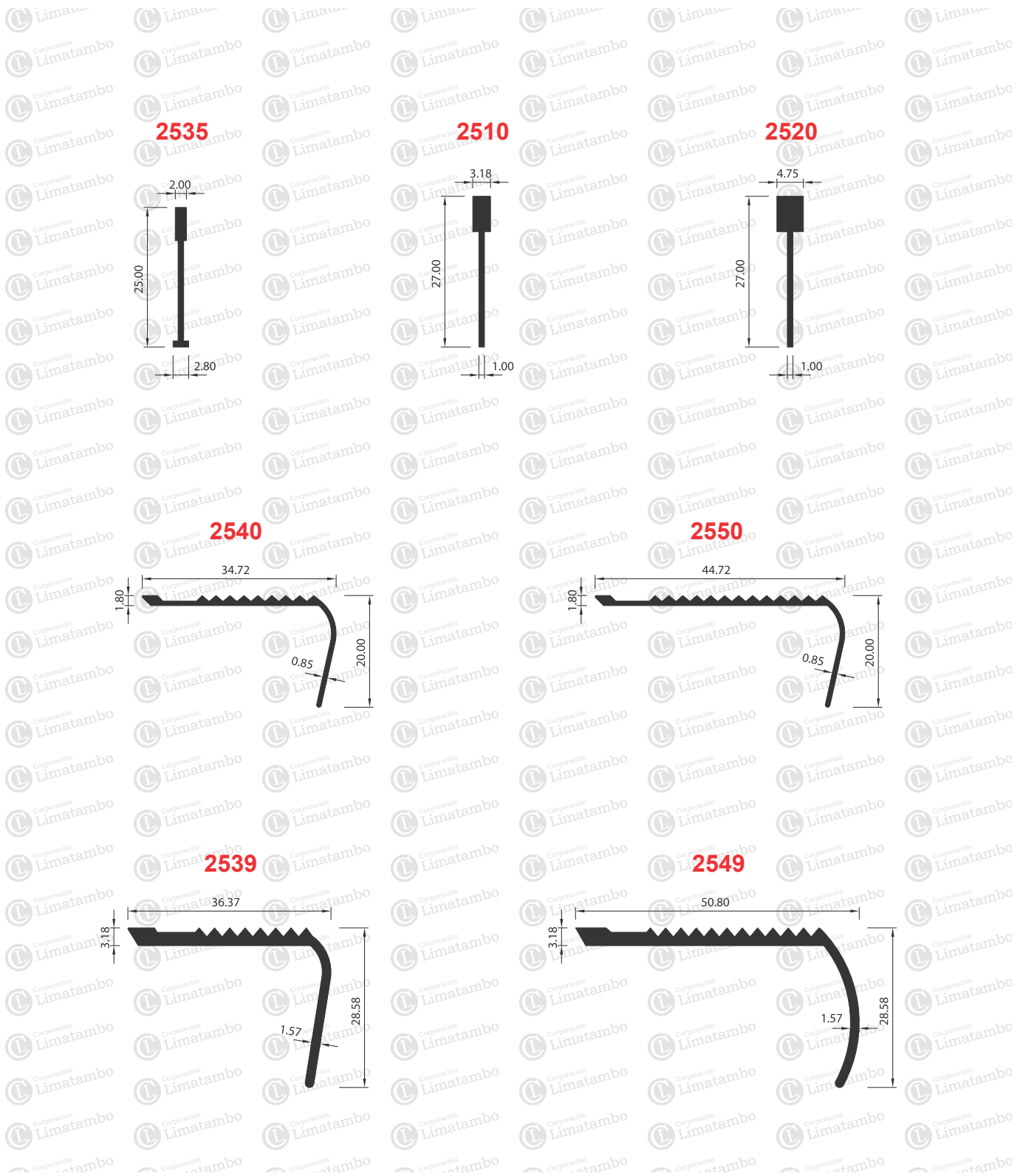

CATÁLOGO DE ALUMINIOS

Medidas en mm/ Escala aproximada 1/1
Espesores con tolerancia ± 0.13 mm. aprox.

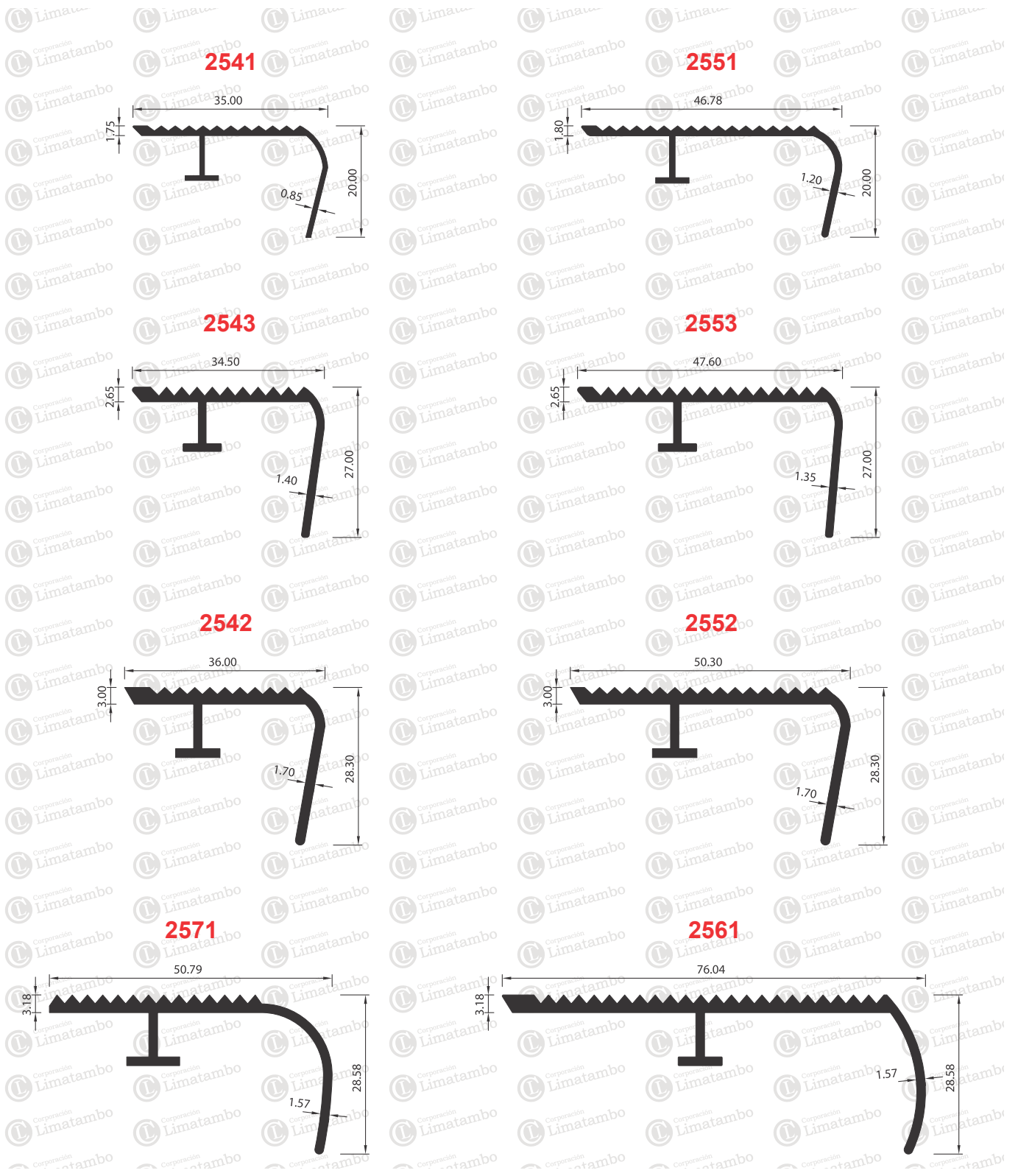

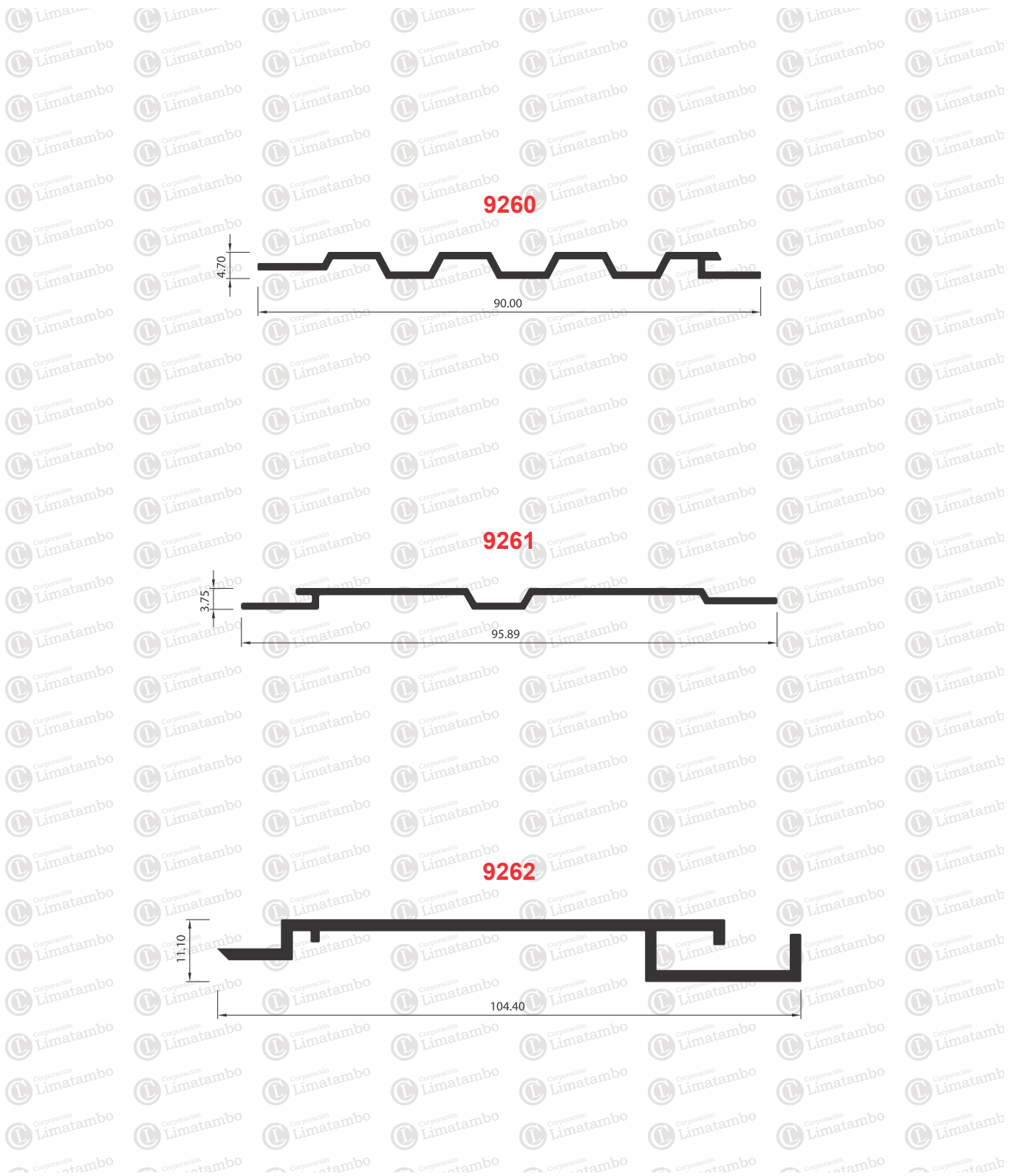

CATÁLOGO DE ALUMINIOS

Medidas en mm/ Escala aproximada 1/1
Espesores con tolerancia ± 0.13 mm. aprox.

2104

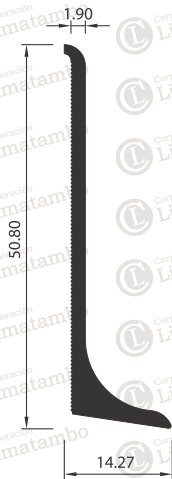

2102

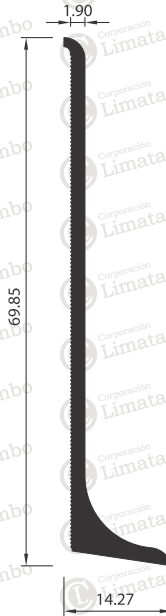

2101

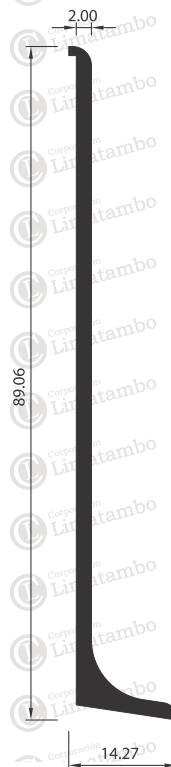

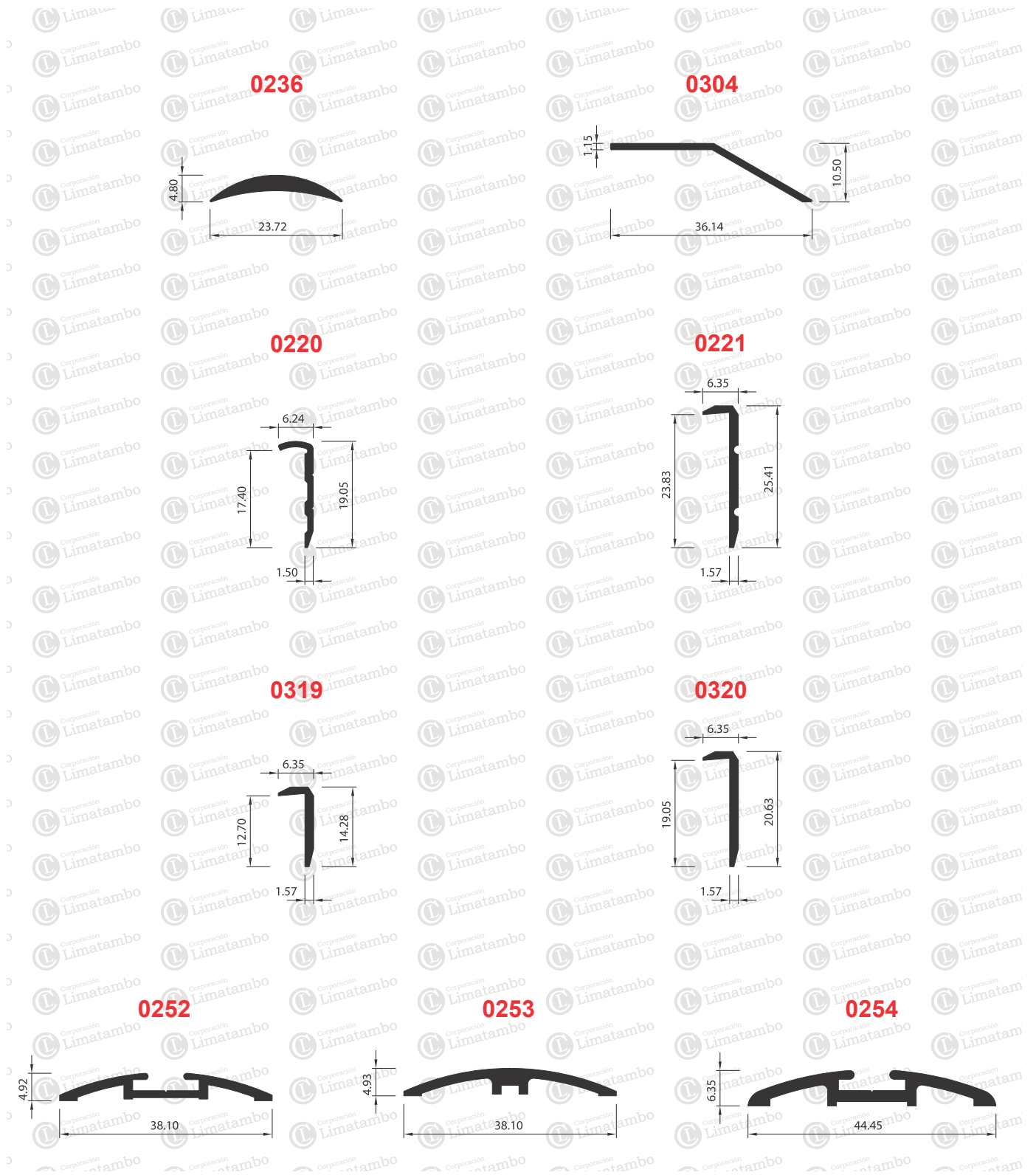

CATÁLOGO DE ALUMINIOS

Medidas en mm/ Escala aproximada 1/1
Espesores con tolerancia ± 0.13 mm. aprox.

8502

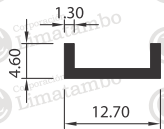

8521

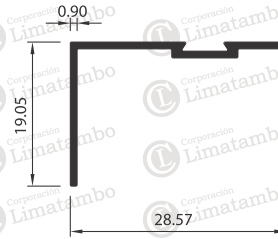

8503

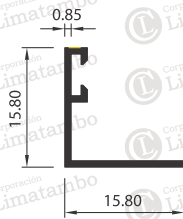

8504

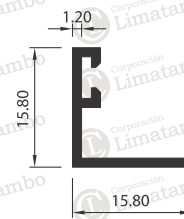

8424

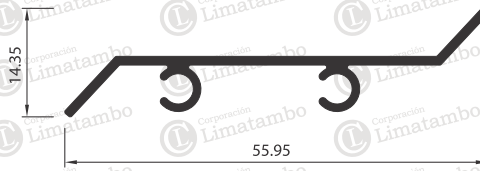

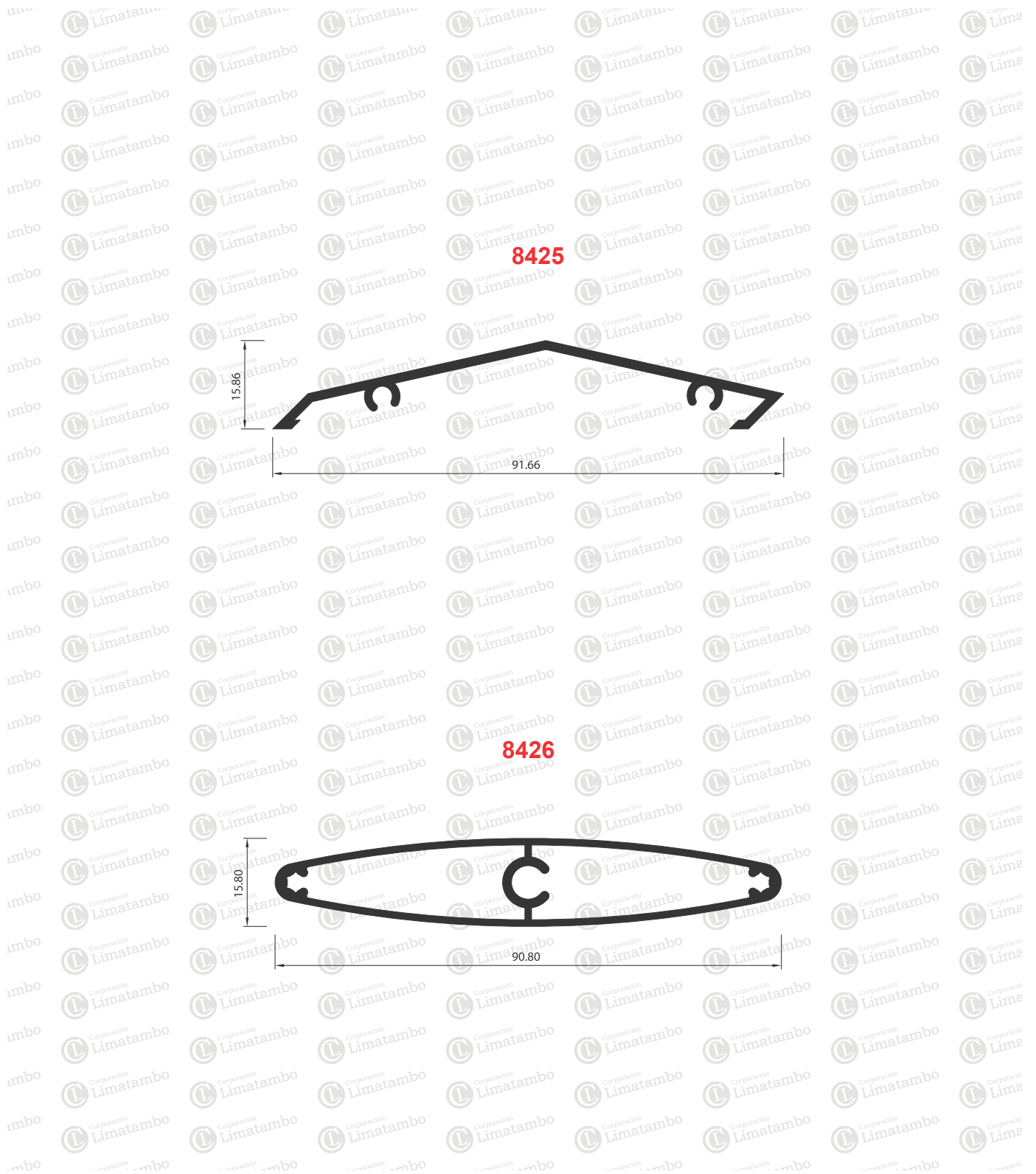

CATÁLOGO DE ALUMINIOS

Medidas en mm/ Escala aproximada 1/1
Espesores con tolerancia ± 0.13 mm. aprox.

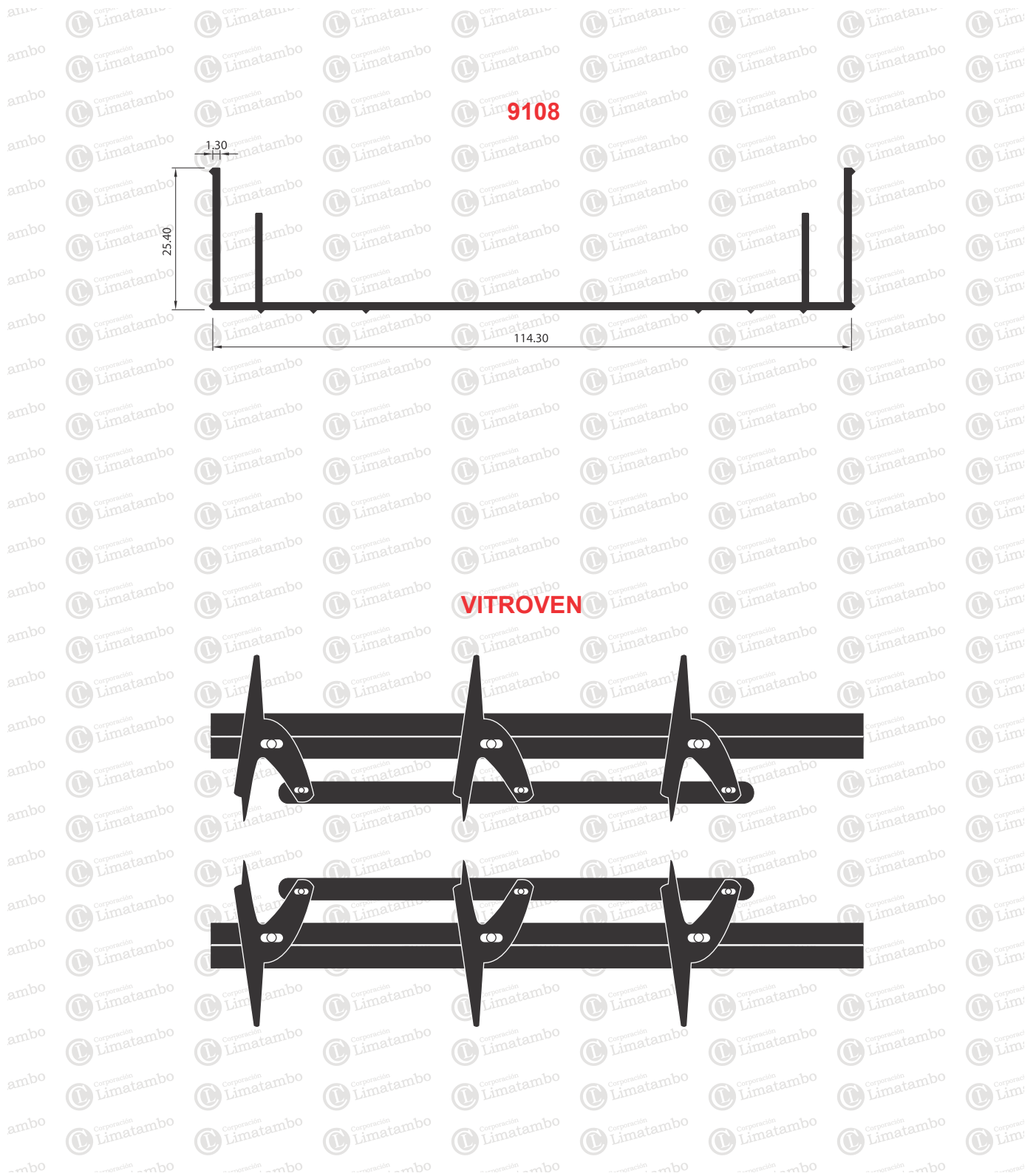

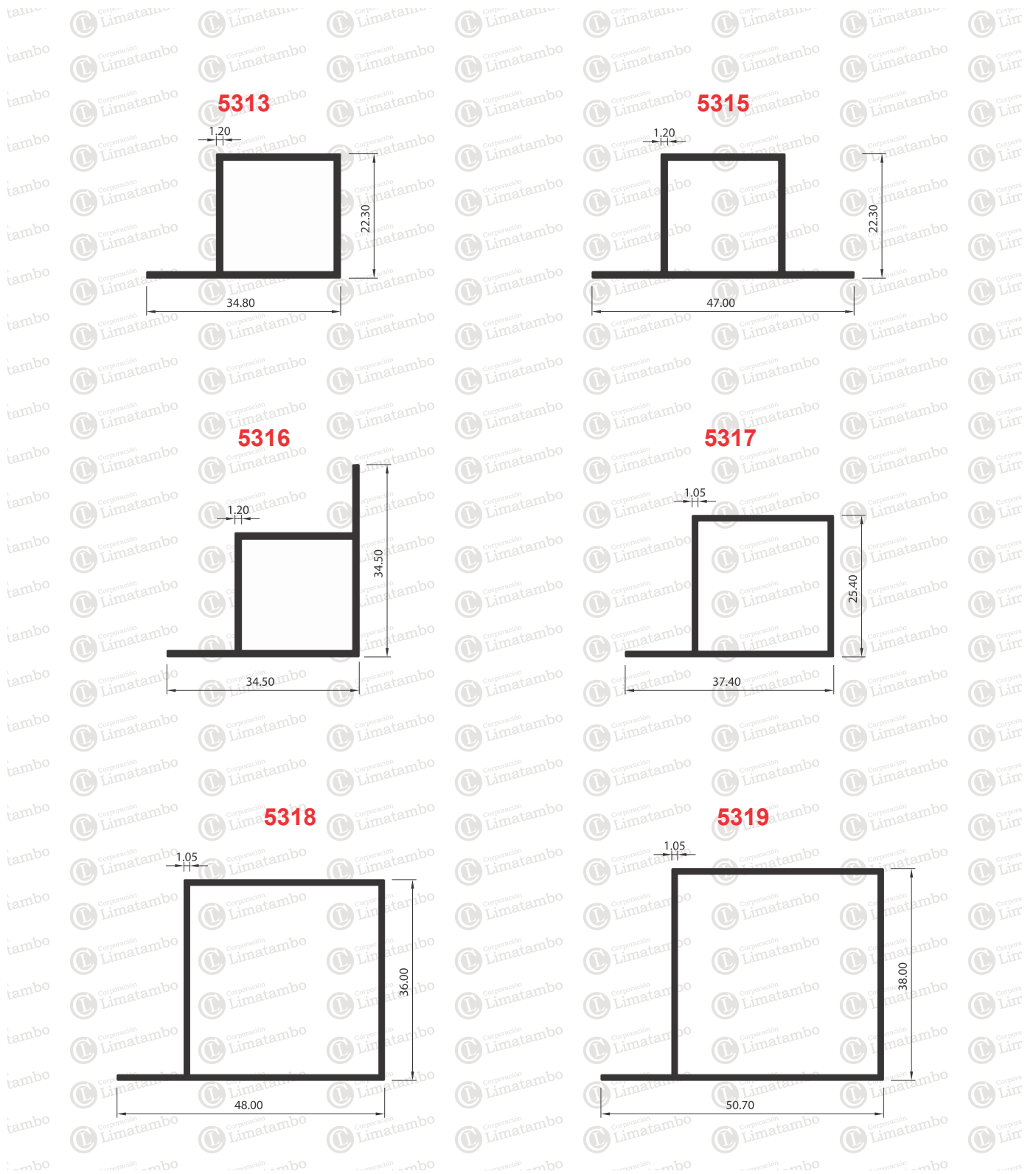

CATÁLOGO DE ALUMINIOS

Medidas en mm/ Escala aproximada 1/1
Espesores con tolerancia ± 0.13 mm. aprox.

5333

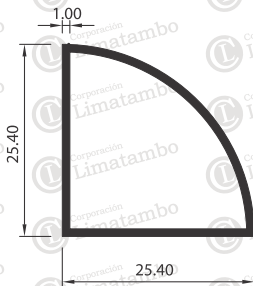

5314

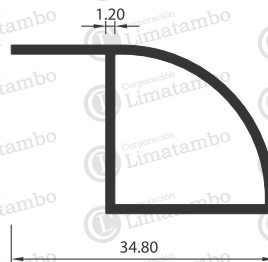

5321

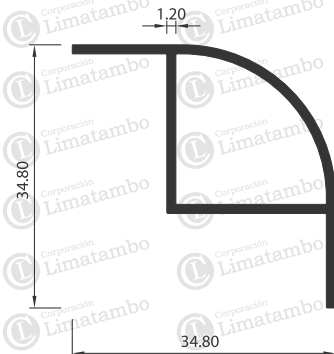

5444

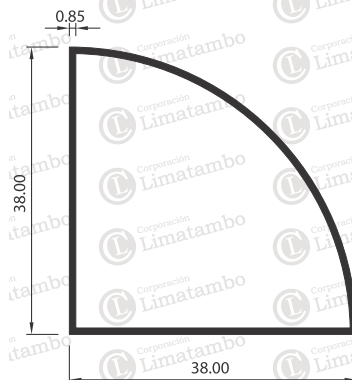

5445

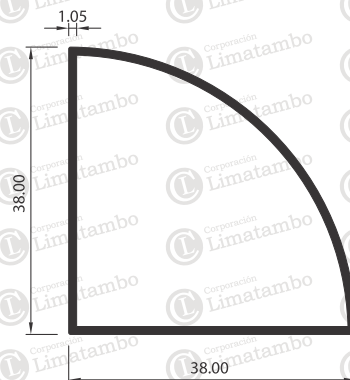

5324

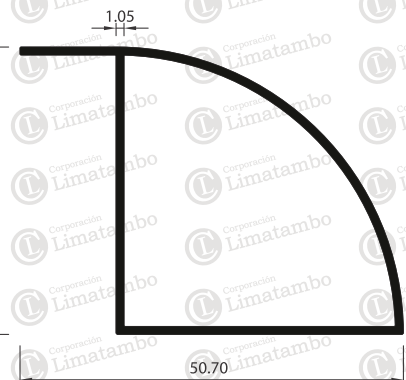

3062

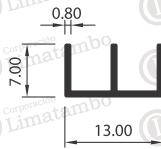

3061

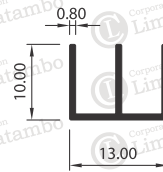

3181

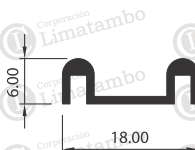

3182

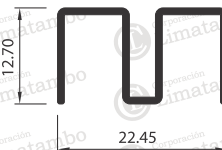

3183

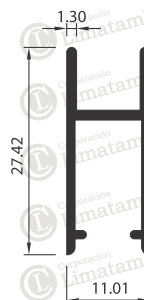

8114

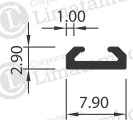

8113

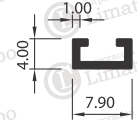

8115

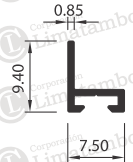

8116

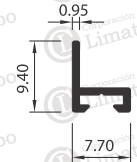

8117

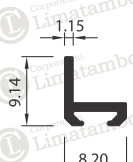

8118



8015



8014

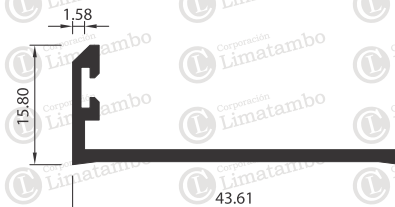

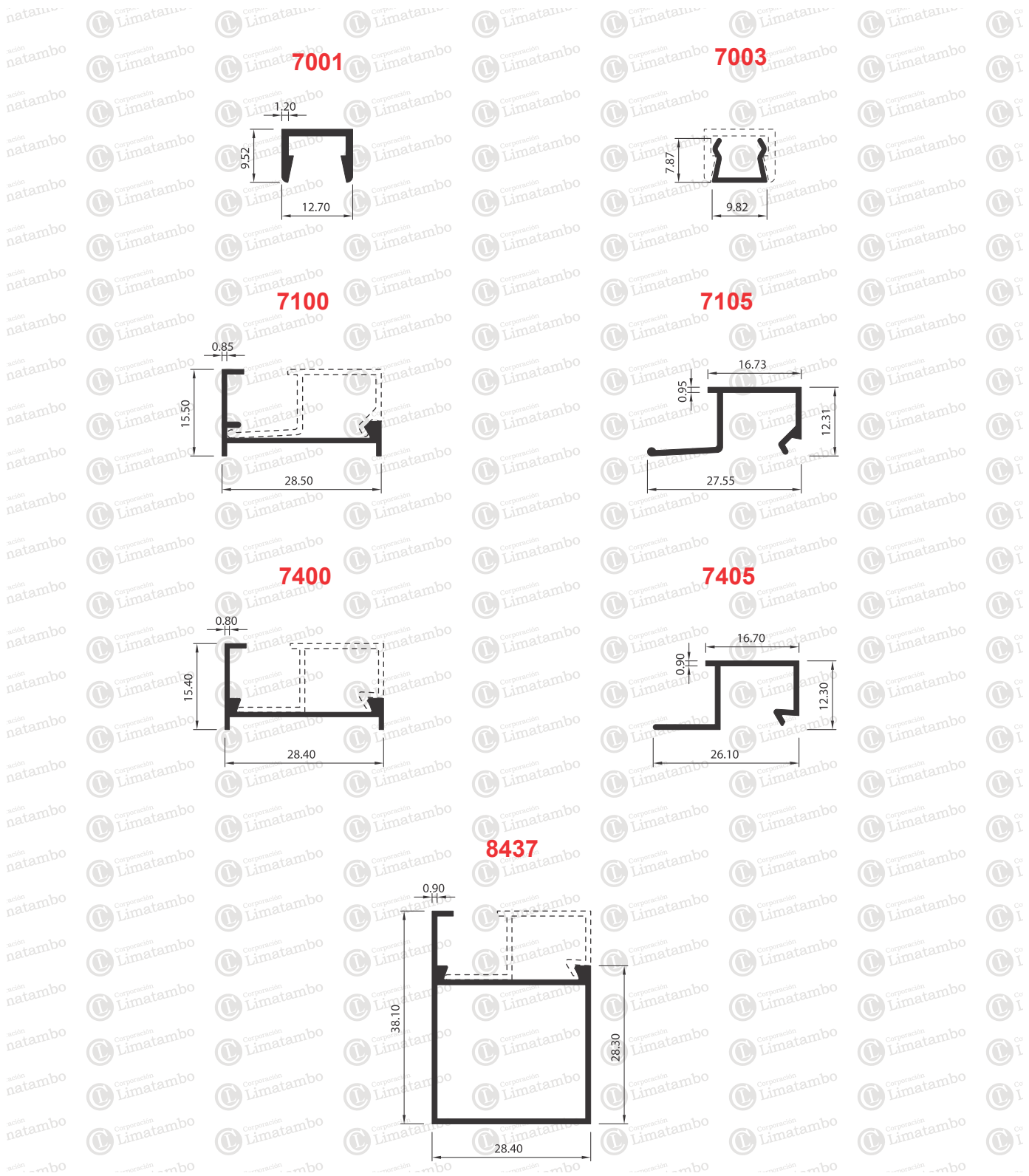

CATÁLOGO DE ALUMINIOS

Medidas en mm/ Escala aproximada 1/1
Espesores con tolerancia ± 0.13 mm. aprox.

7200

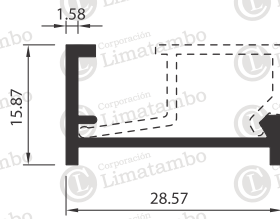

7205

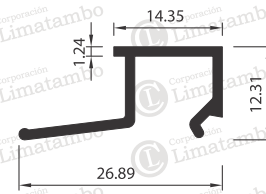

7210

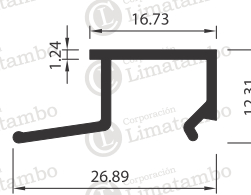

5438

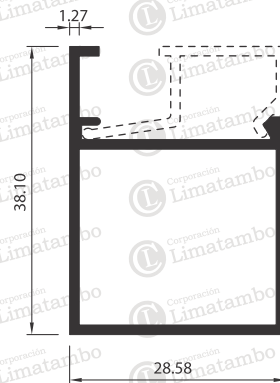

5282

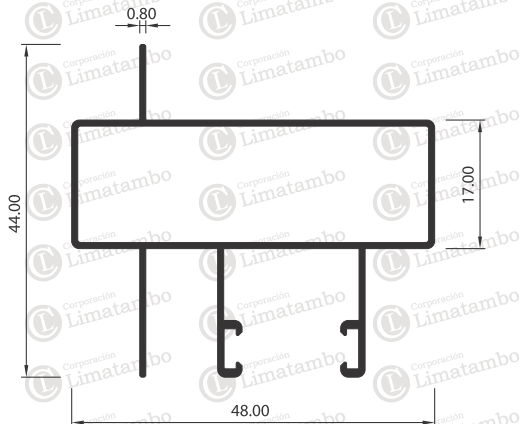

2005

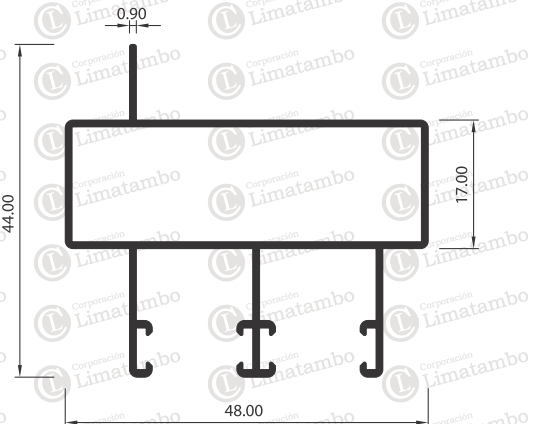

5283

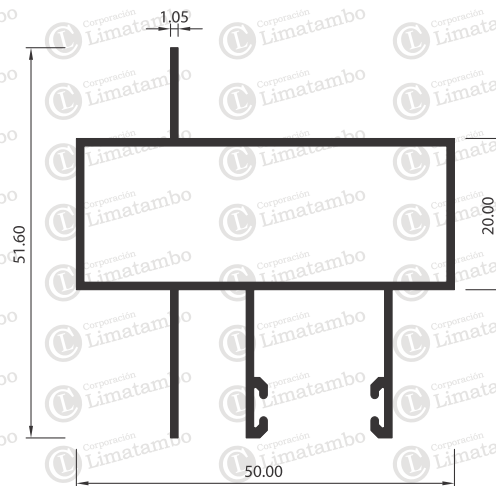

CATÁLOGO DE ALUMINIOS

Medidas en mm/ Escala aproximada 1/1
Espesores con tolerancia ± 0.13 mm. aprox.

8482

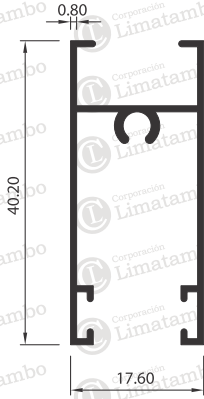

8483

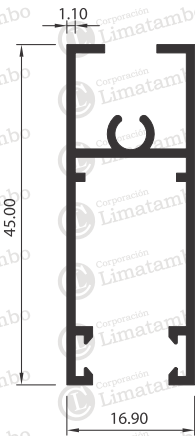

8488

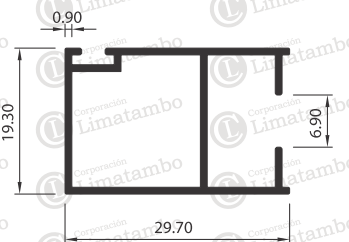

8489

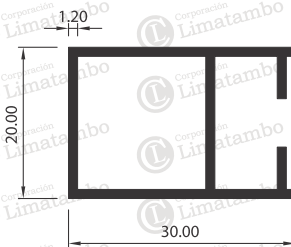

8438

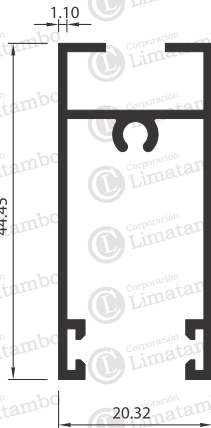

8436

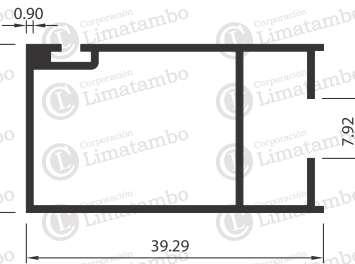

8440

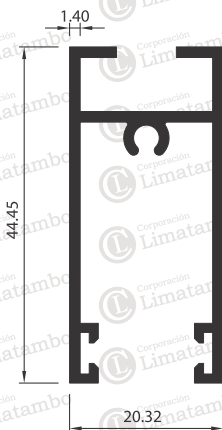

8441

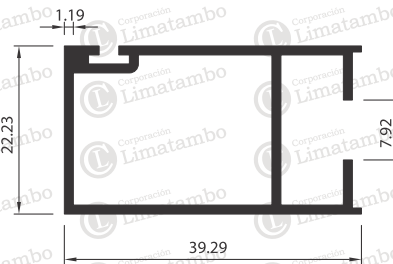

CATÁLOGO DE ALUMINIOS

Medidas en mm/ Escala aproximada 1/1
Espesores con tolerancia ± 0.13 mm. aprox.



8461

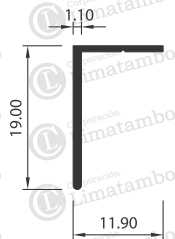

8462

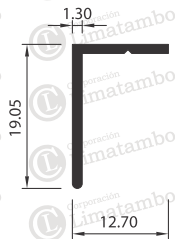

8465

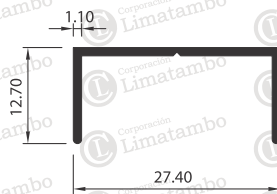

8411

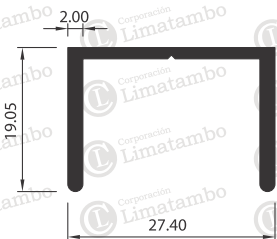

8412

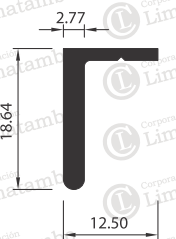

8410

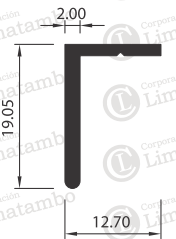

8464

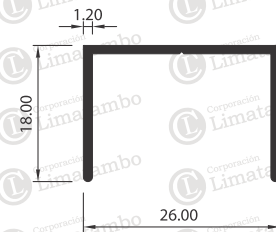

8416

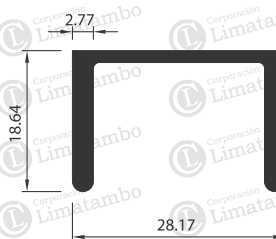

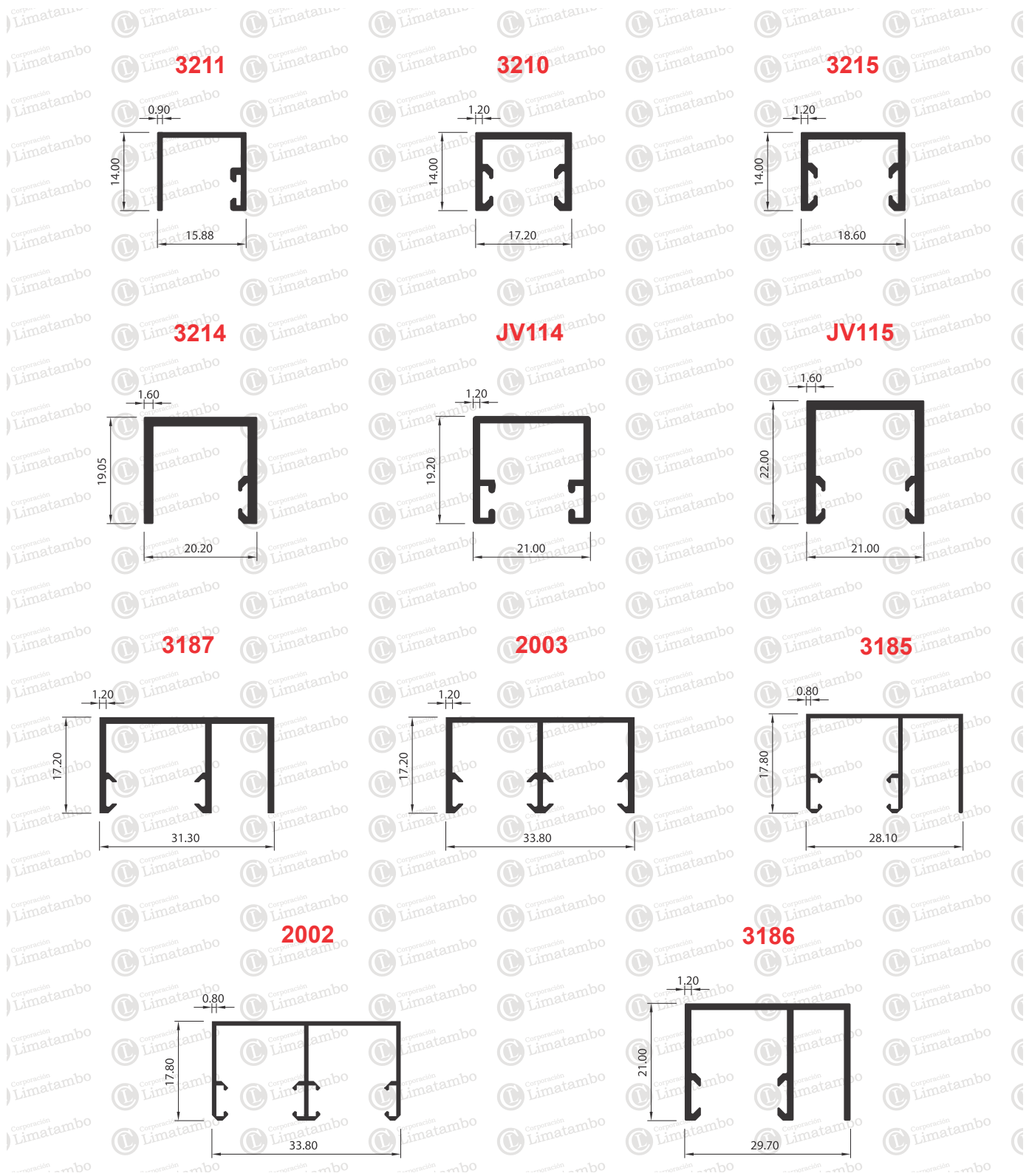

CATÁLOGO DE ALUMINIOS

Medidas en mm/ Escala aproximada 1/1
Espesores con tolerancia ± 0.13 mm. aprox.



8314

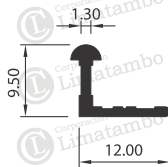

8413

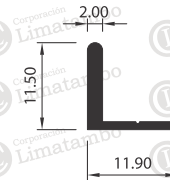

8463

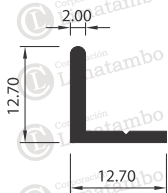

8313

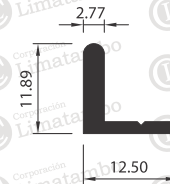

8443

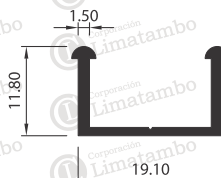

8444

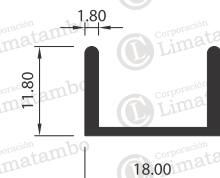

8445

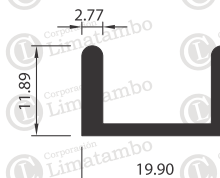

8414

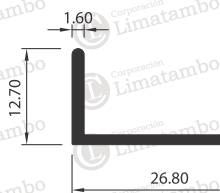

8415

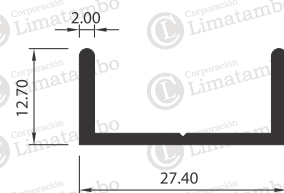

8417

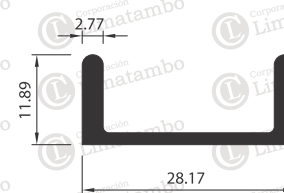

2244



2243

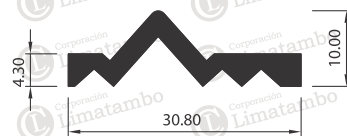

2248



2246



2242



1164

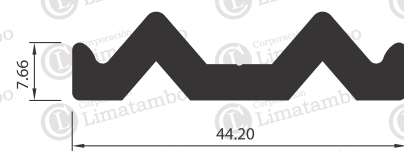

2245

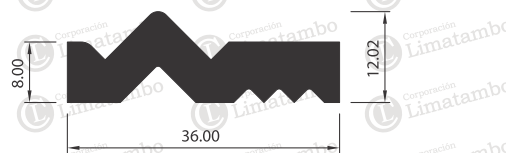

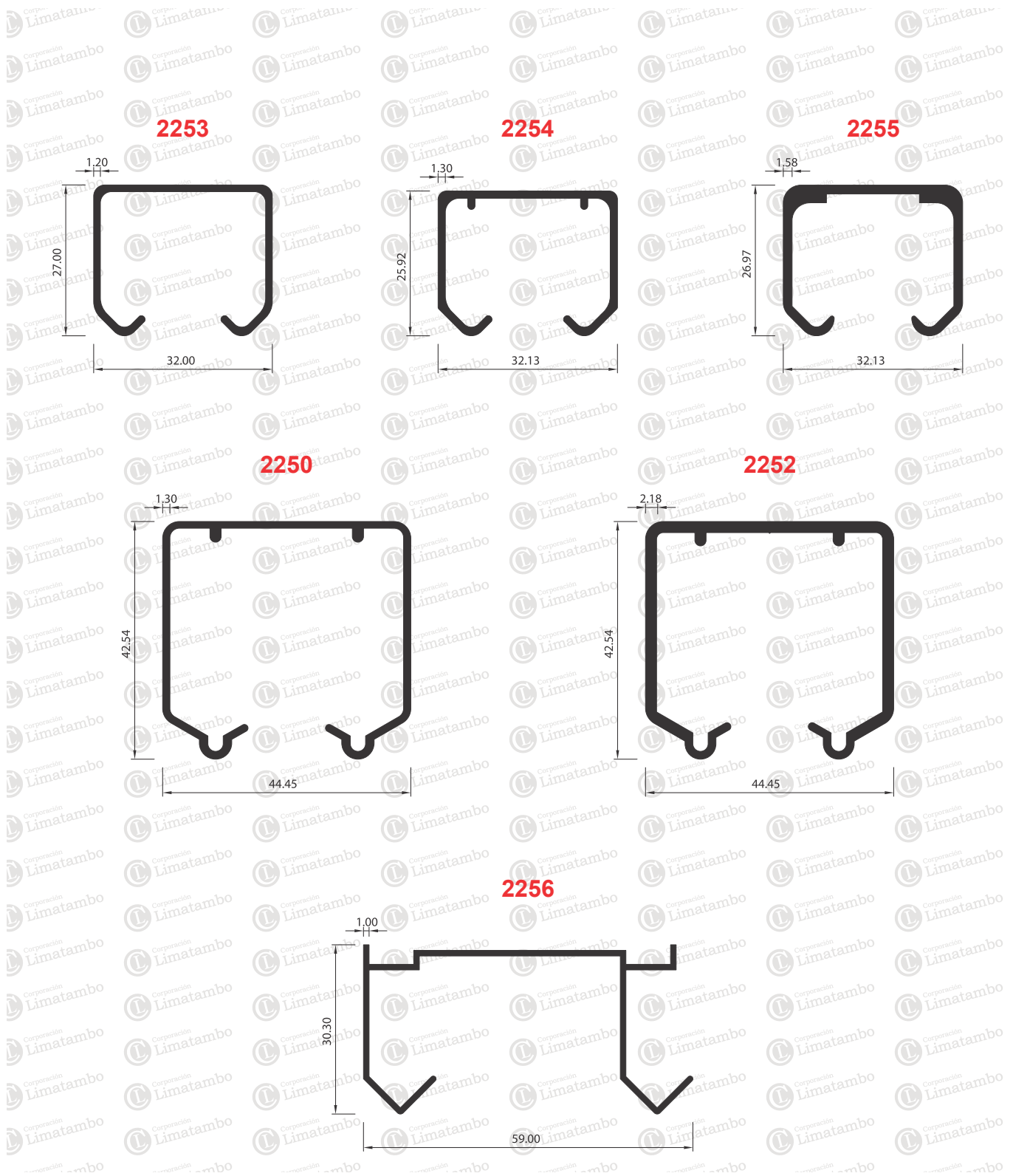



8220

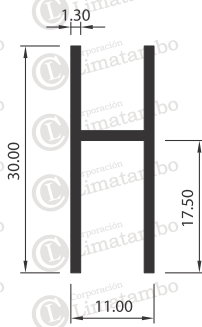

8221

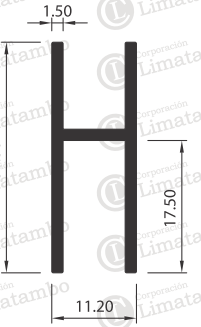

8223

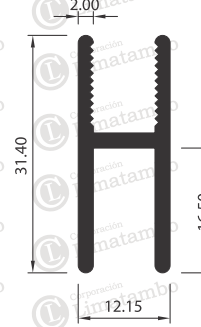

8222

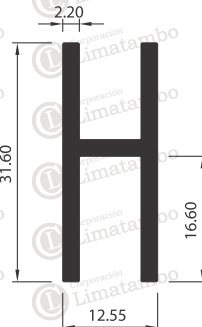

8224

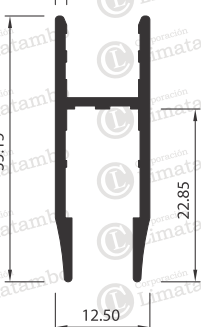

9149

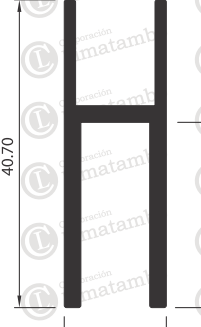

9150

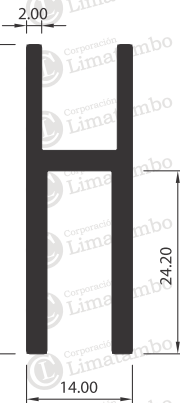

9151

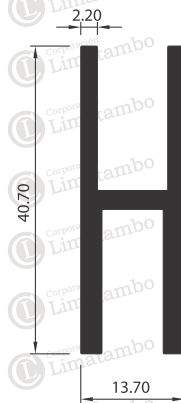

CATÁLOGO DE ALUMINIOS

Medidas en mm/ Escala aproximada 1/1
Espesores con tolerancia ± 0.13 mm. aprox.

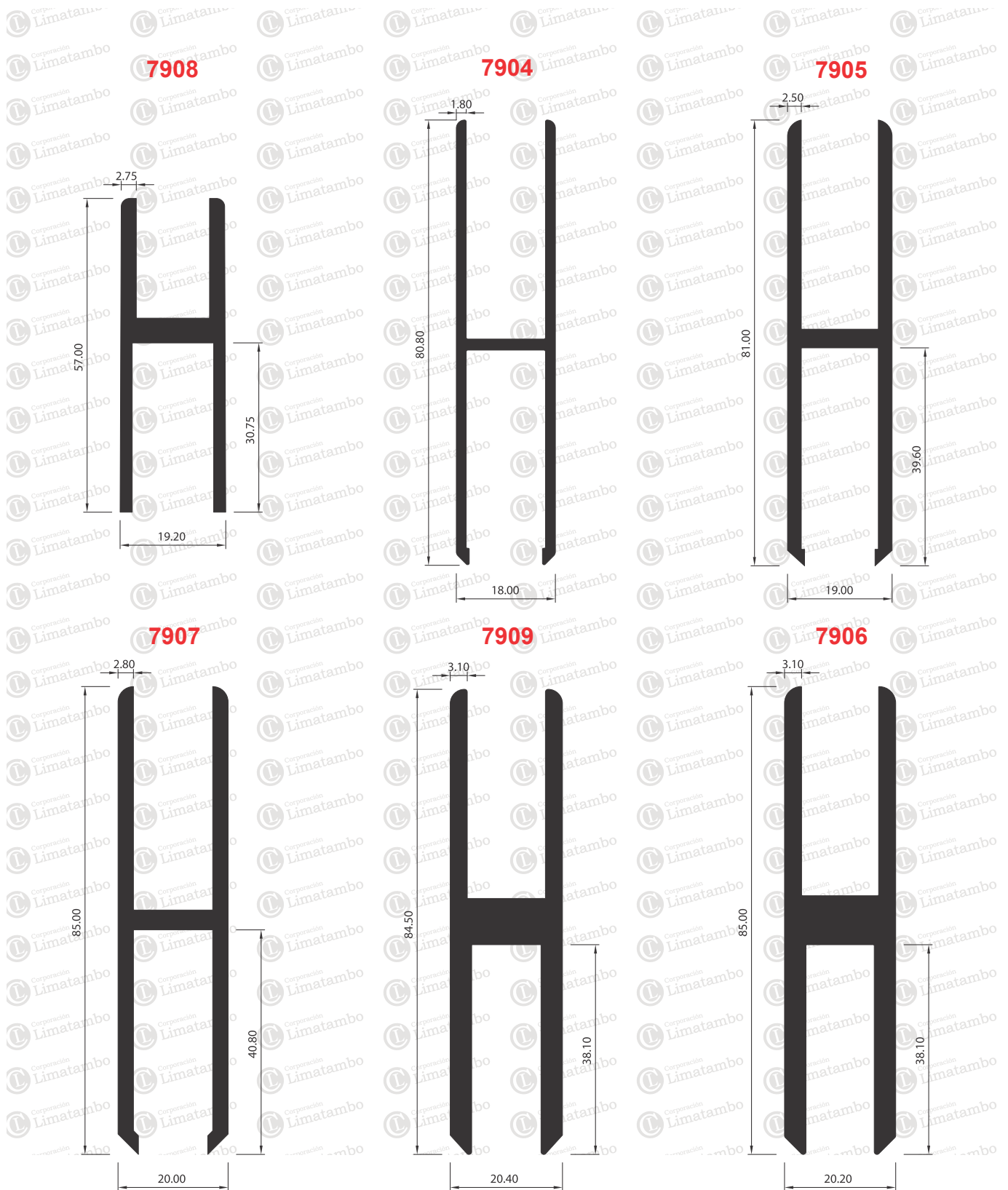

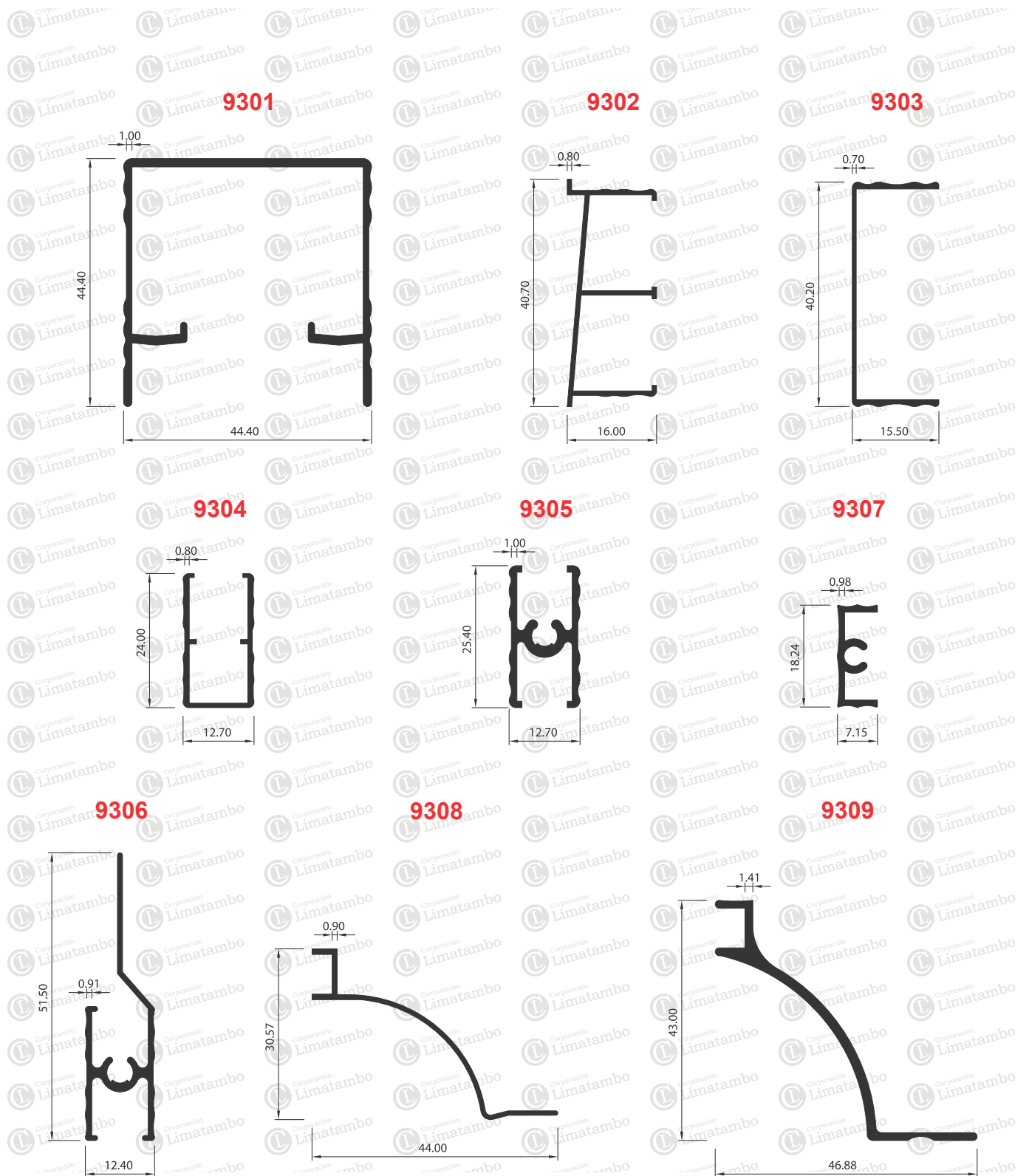

CATÁLOGO DE ALUMINIOS

Medidas en mm/ Escala aproximada 1/1

Espesores con tolerancia ± 0.13 mm. aprox.



1202

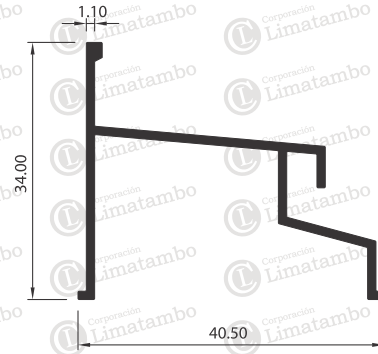

9401

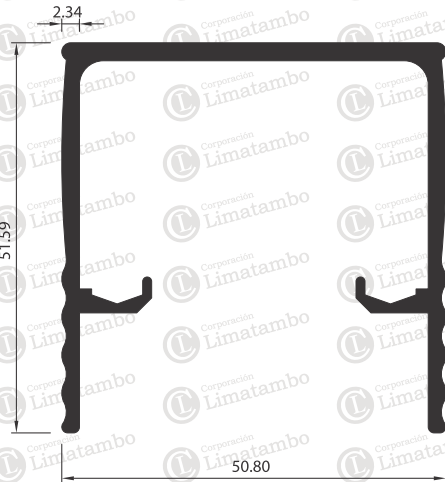

9403

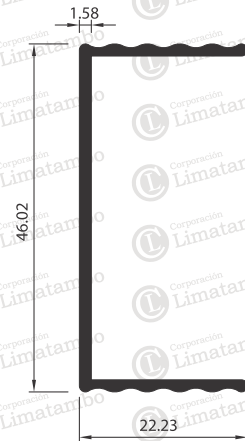

9404

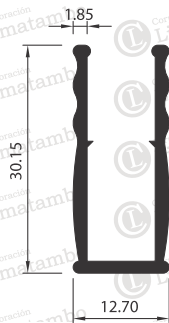



1399

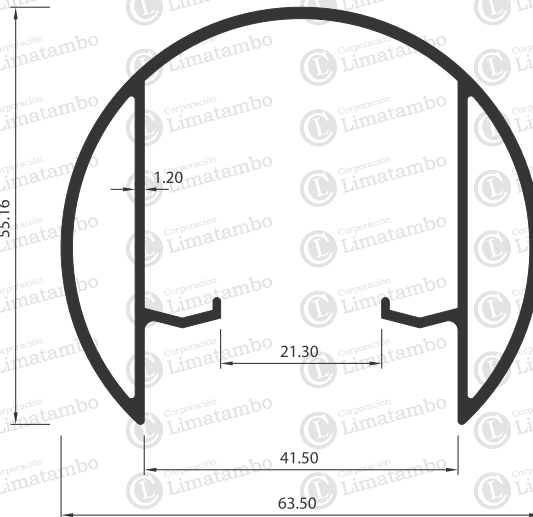

1401

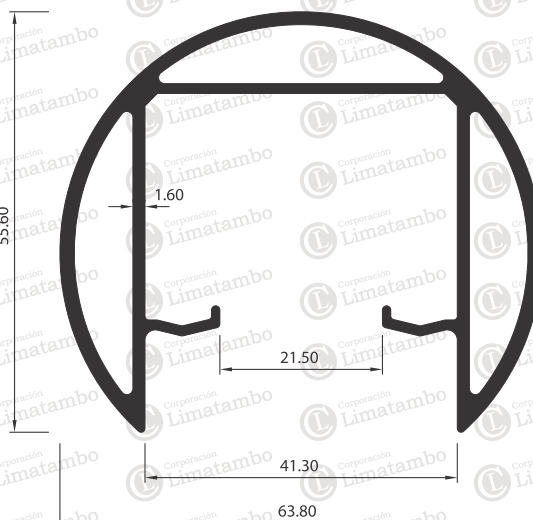

CATÁLOGO DE ALUMINIOS

Medidas en mm/ Escala aproximada 1/1
Espesores con tolerancia ± 0.13 mm. aprox.



0281

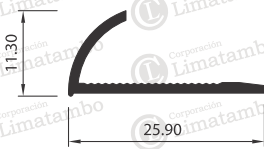

0280

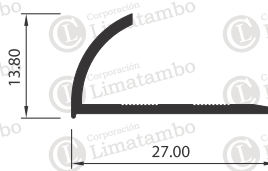

2260

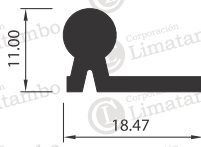

2261

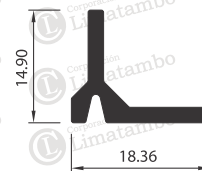

0110

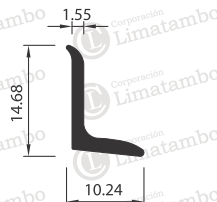

8449

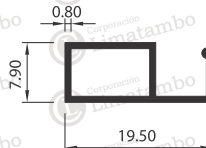

2259

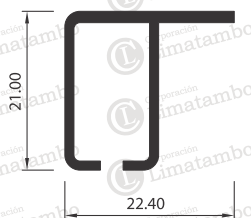

9007

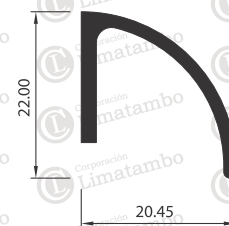

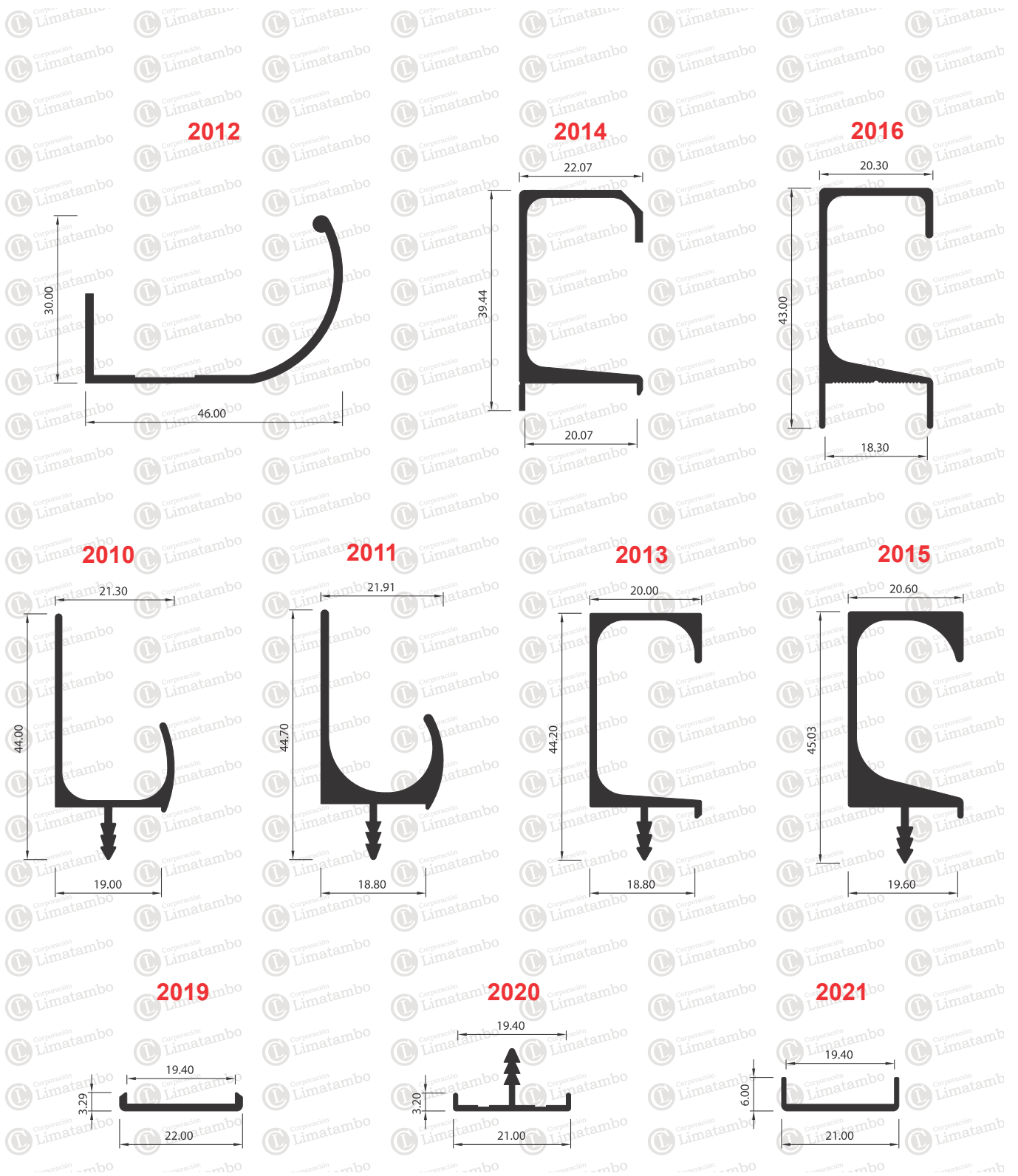

CATÁLOGO DE ALUMINIOS

Medidas en mm/ Escala aproximada 1/1
Espesores con tolerancia ± 0.13 mm. aprox.

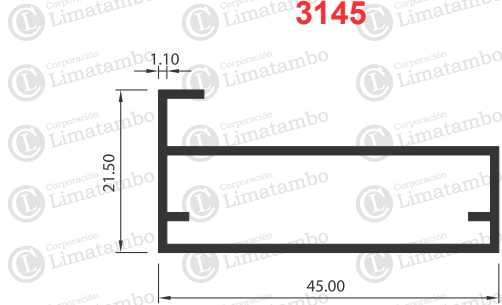
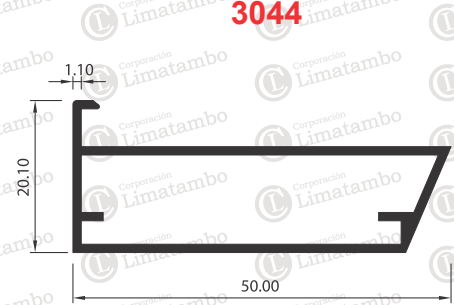
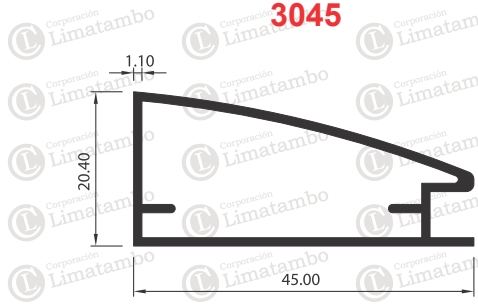
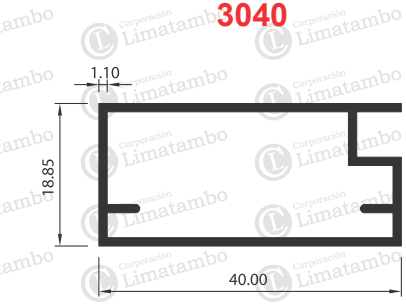
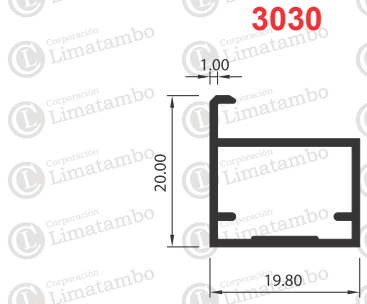
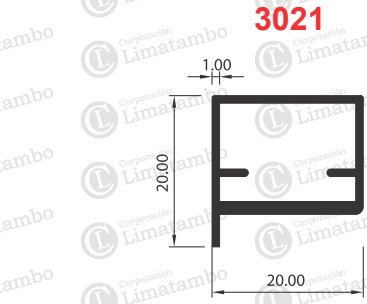
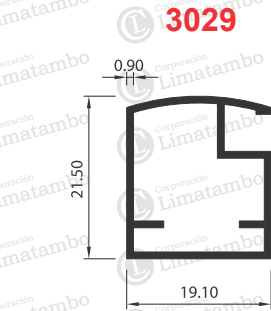
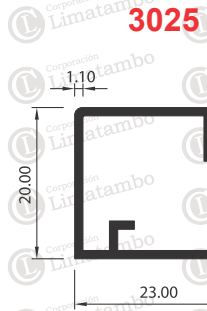
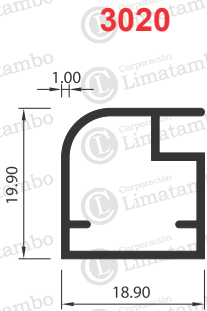

CL1001

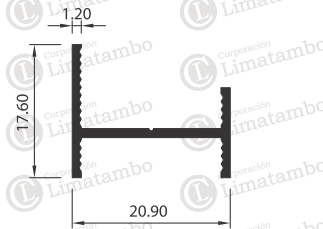

CL1003



CL1006

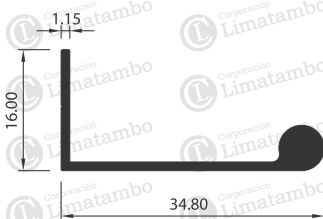

CL1007

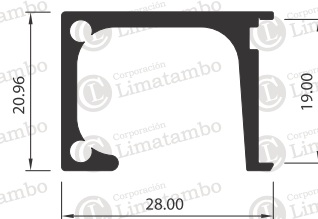

CL1002

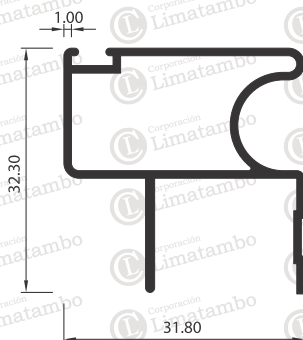

CL1004

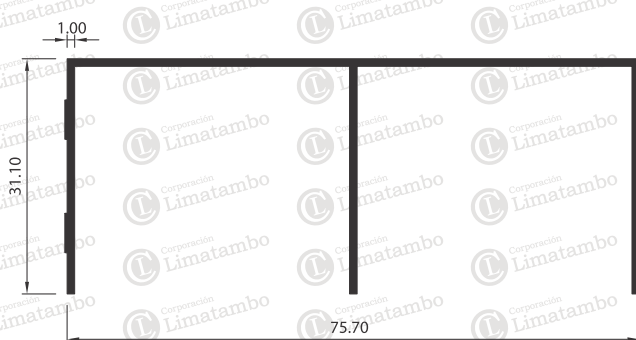

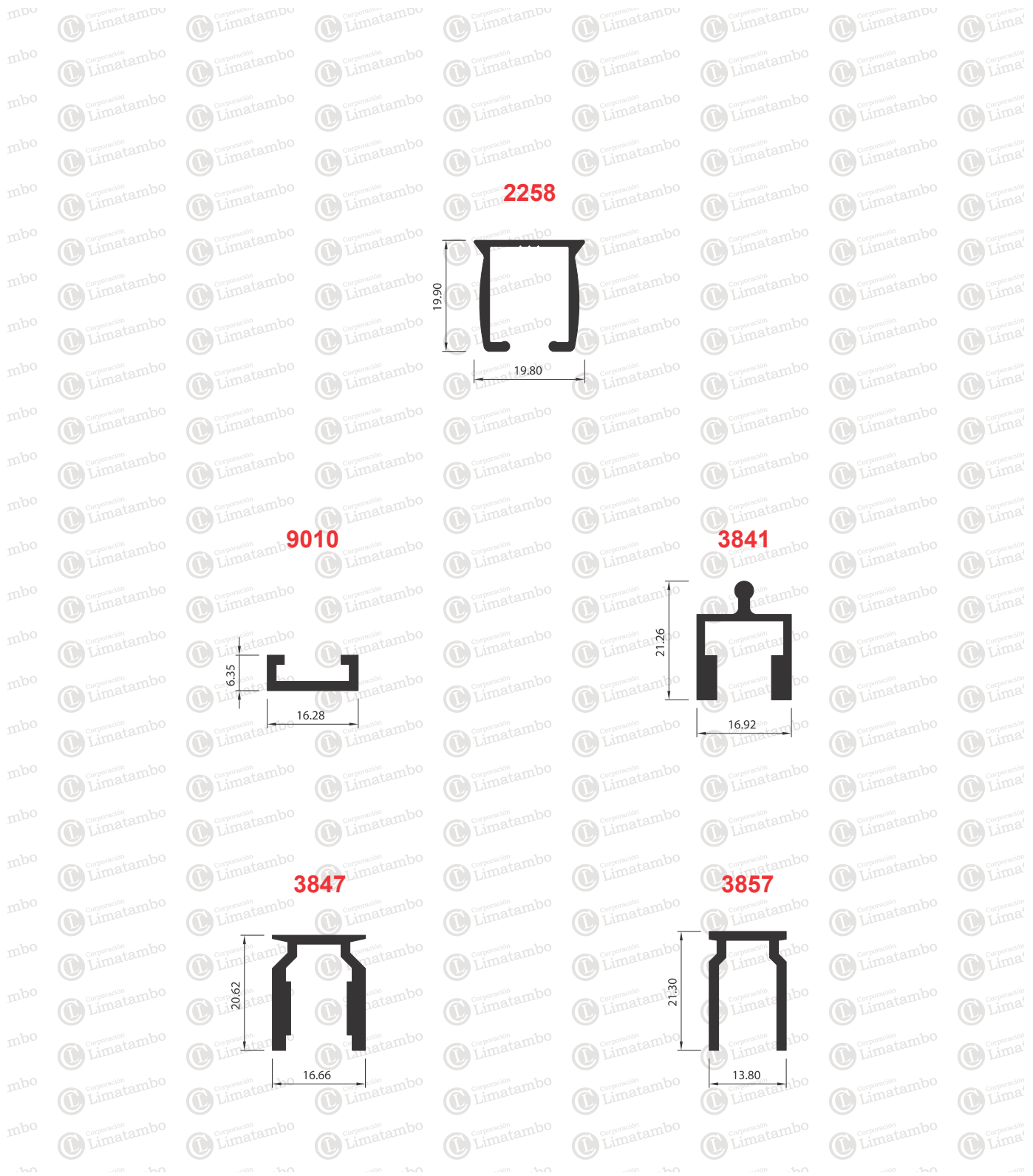

2220

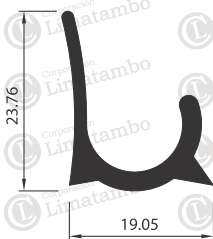

2219

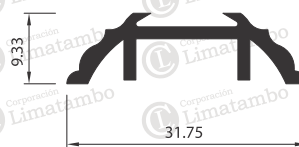

2218



2217

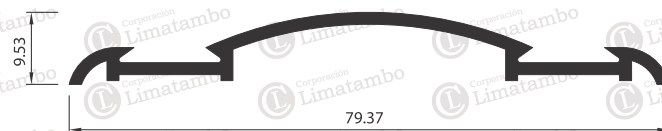

2216



CATÁLOGO DE ALUMINIOS

Medidas en mm/ Escala aproximada 1/1
Espesores con tolerancia ± 0.13 mm. aprox.

PERFILES DE SERIES EN CARPINTERÍA DE ALUMINIO

CONTENIDO

VENTANA CORREDIZA ECONÓMICA SERIE 35	68
VENTANA CORREDIZA SERIE 19	70
VENTANA CORREDIZA SERIE VL42	72
MAMPARA CORREDIZA SERIE ML42	75
VENTANA Y/O MAMPARA CORREDIZA SERIE 26	78
VENTANA CORREDIZA SERIE EUROPEA VL46	80
MAMPARA CORREDIZA SERIE EUROPEA ML46	83
VENTANA CORREDIZA SERIE EUROPEA VL48	85
MAMPARA CORREDIZA SERIE EUROPEA ML48	87



PERFILES DE SERIES EN CARPINTERÍA DE ALUMINIO

CONTENIDO

VENTANA APERTURA INTERIOR - OSCIOBATIENTE - OSCILANTE - PROYECTANTE -BATIENTE - SERIE EUROPEA VLP46	89
VENTANA APERTURA EXTERIOR - OSCILANTE - PROYECTANTE -BATIENTE - SERIE EUROPEA VLP46	91
PUERTA BATIENTE APERTURA INTERIOR SERIE EUROPEA PLB47	93
SISTEMA PLEGABLE SERIE EUROPEA PLE47	95
PUERTA BATIENTE APERTURA EXTERIOR SERIE EUROPEA PLB47	96
VENTANA PROYECTANTE SERIE 38	98
VENTANA PROYECTANTE SERIE 36	99
MAMPARA BATIENTE SERIE 45	101
MAMPARA BATIENTE SERIE MBL46	103
MURO CORTINA STICK SERIE 44	107



3501

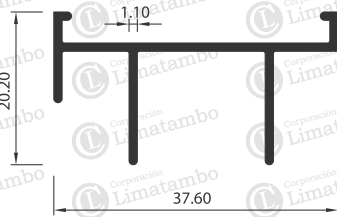

MARCO SUP. DOBLE CORREDIZA

3502

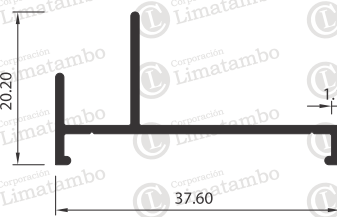

MARCO SUP. FIJA CORREDIZA

3503

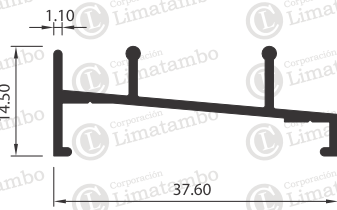

MARCO INF. DOBLE CORREDIZA

3504

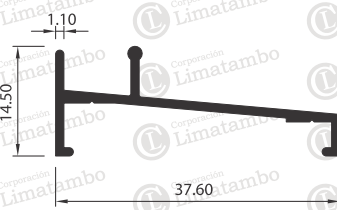

MARCO INF. FIJA CORREDIZA

3505

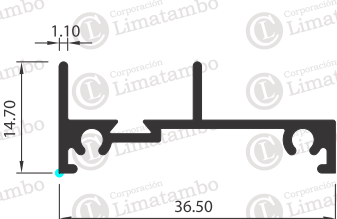

MARCO LATERAL

3506

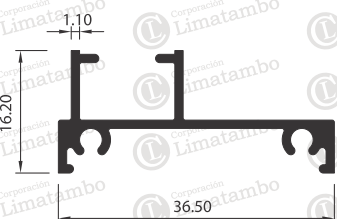

MARCO LATERAL FIJO

3507

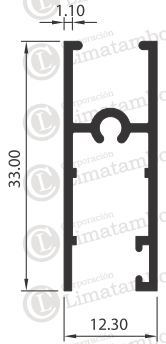

**MARCO DE HOJA SUP. E INF.
CORREDIZA**

3508

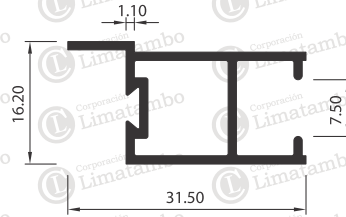

**MARCO DE HOJA ENCUENTRO
CORREDIZAS**

3509

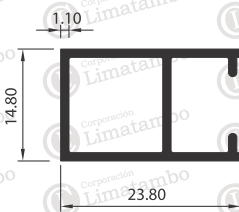

MARCO DE HOJA VERTICAL

3510

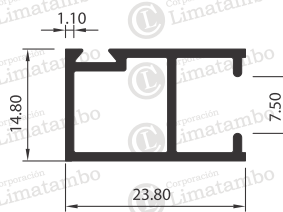

TRASLAPE DE HOJA

3511

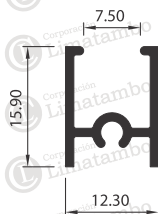

MARCO DE HOJA FIJO

3513

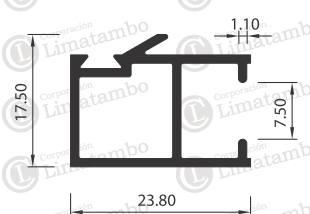

TRASLAPE DE HOJA

1901

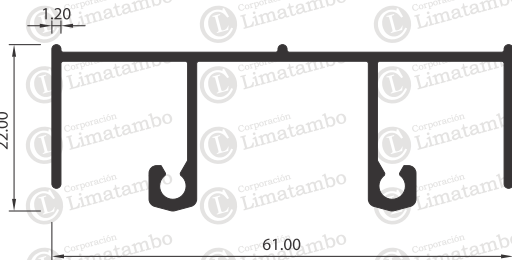

MARCO SUPERIOR

1902

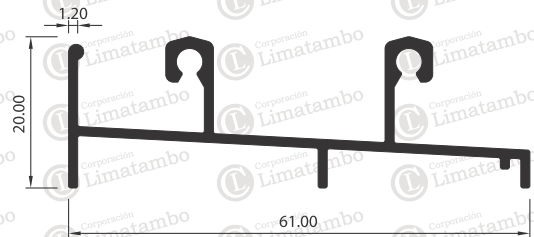

MARCO INFERIOR

1904

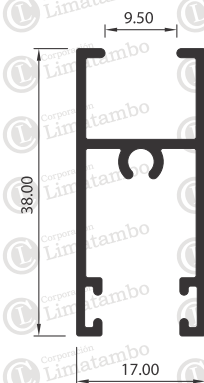

MARCO DE HOJA SUPERIOR

1905

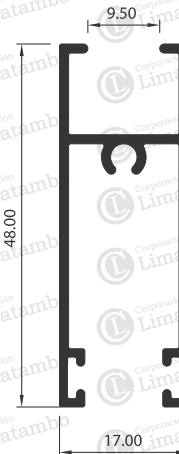

MARCO DE HOJA INFERIOR

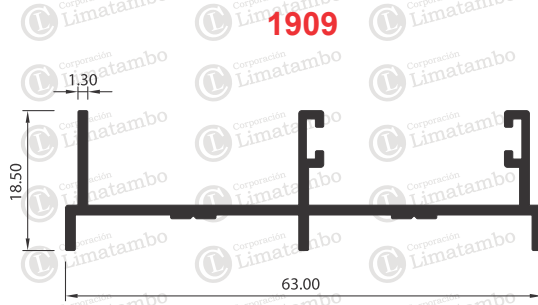

MARCO LATERAL

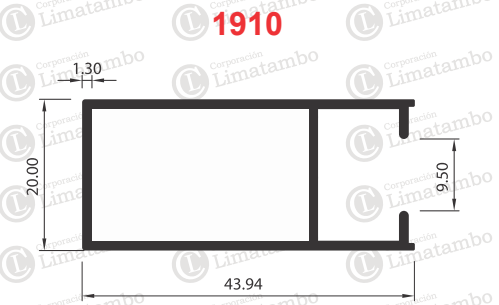

MARCO DE HOJA LATERAL

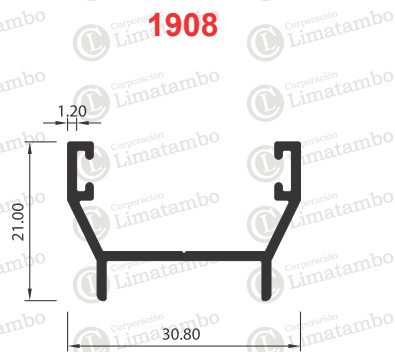

PERFIL ADAPTADOR DE HOJA

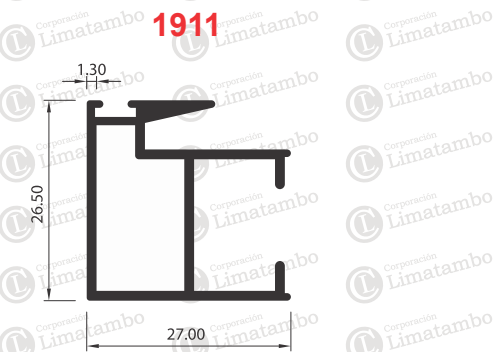

TRASLAPE

VL4201

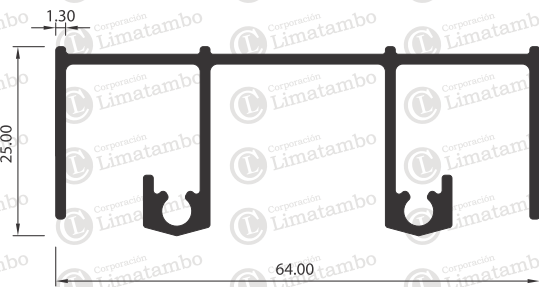

MARCO SUPERIOR

VL4202

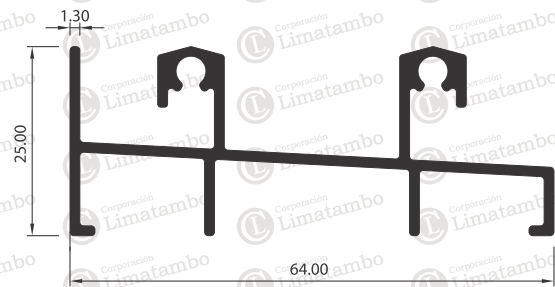

MARCO INFERIOR

VL4206

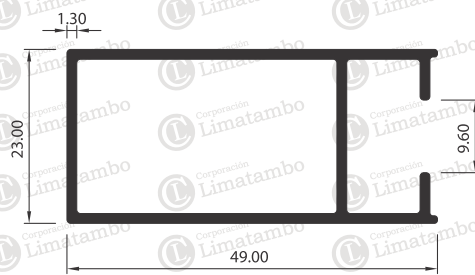

MARCO DE HOJA LATERAL

VL4208

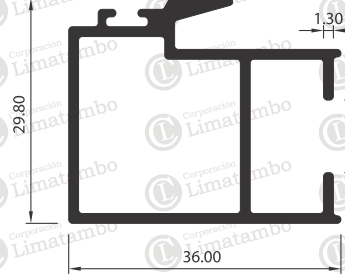

TRASLAPE DE HOJA

VL4209

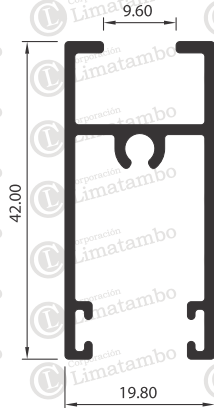

ZÓCALO DE HOJA SUPERIOR

VL4210

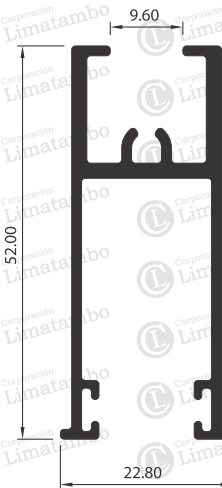

ZÓCALO DE HOJA INFERIOR

VL4215

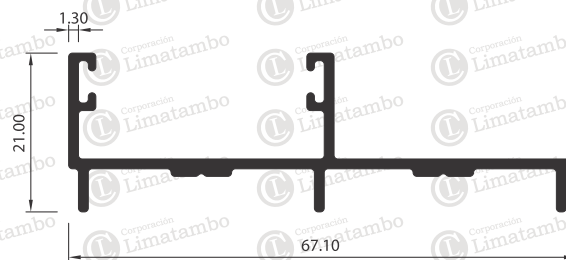

MARCO LATERAL

CATÁLOGO DE ALUMINIOS

Medidas en mm/ Escala aproximada 1/1
Espesores con tolerancia ± 0.13 mm. aprox.

VL4216

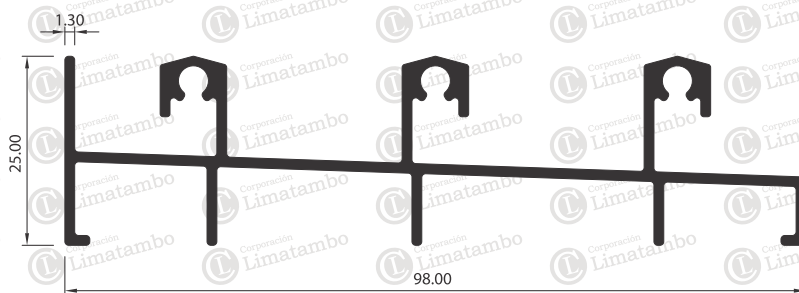

MARCO INFERIOR TRIPLE CARRIL

VL4217

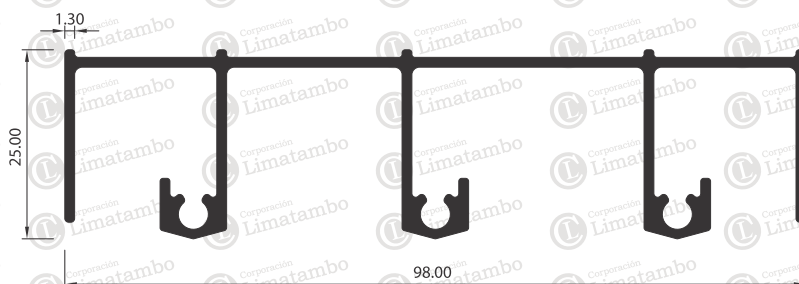

MARCO SUPERIOR TRIPLE CARRIL

VL4218

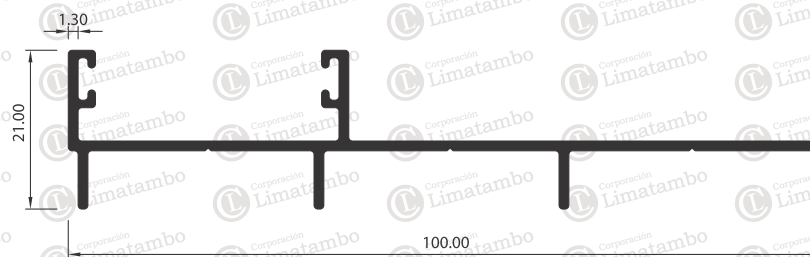

MARCO LATERAL TRIPLE CARRIL

VL4201

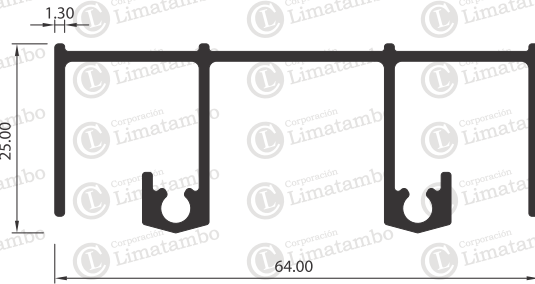

MARCO SUPERIOR

ML4205

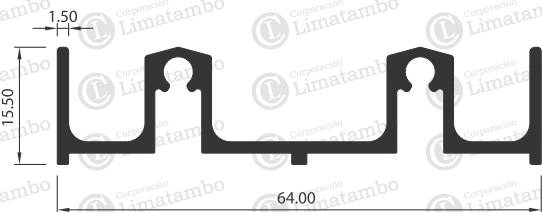

MARCO INFERIOR

ML4207

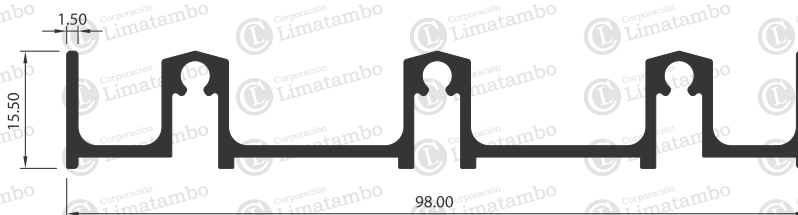

MARCO INFERIOR TRIPLE CARRIL

CATÁLOGO DE ALUMINIOS

Medidas en mm/ Escala aproximada 1/1
Espesores con tolerancia ± 0.13 mm. aprox.



VL4206



MARCO DE HOJA LATERAL

ML4204

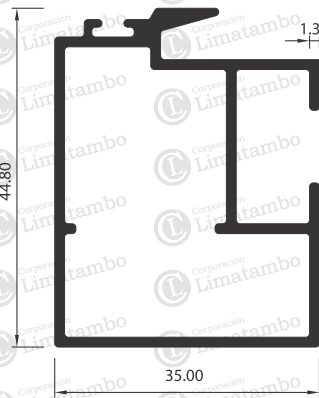

TRASLAPE DE HOJA

ML4203

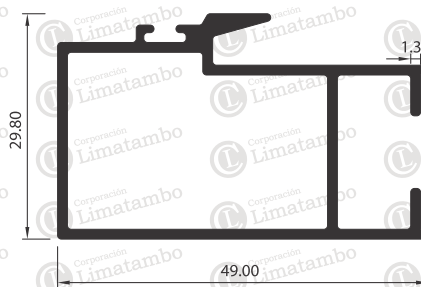

TRASLAPE DE HOJA

VL4209

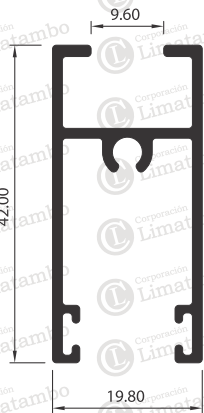

ZÓCALO DE HOJA SUPERIOR

ML4201



ZÓCALO DE HOJA INFERIOR

ML4214

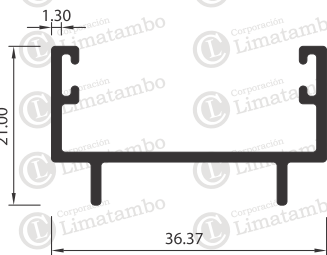

PERFIL ADAPTADOR DE HOJA

VL4215

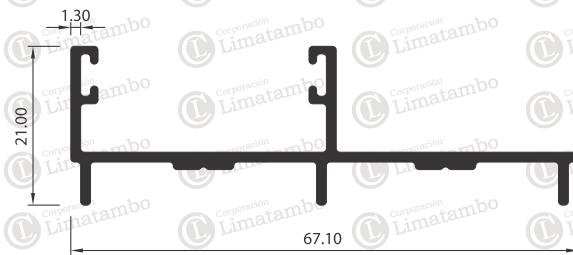

MARCO LATERAL



2601

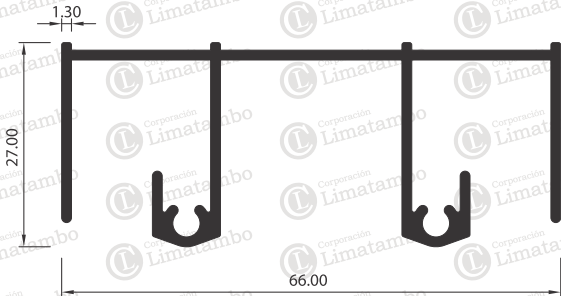

MARCO SUPERIOR

2603

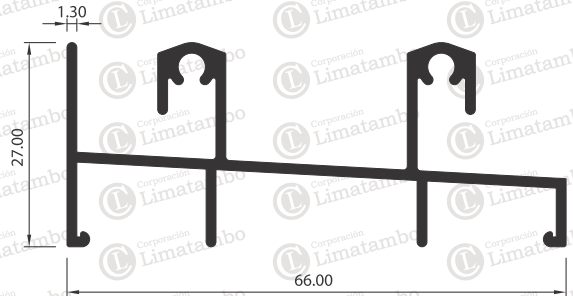

MARCO INFERIOR

2604

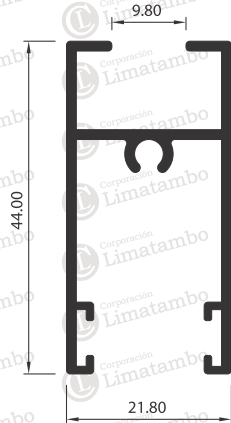

ZÓCALO DE HOJA SUPERIOR

2605



ZÓCALO DE HOJA INFERIOR



2607

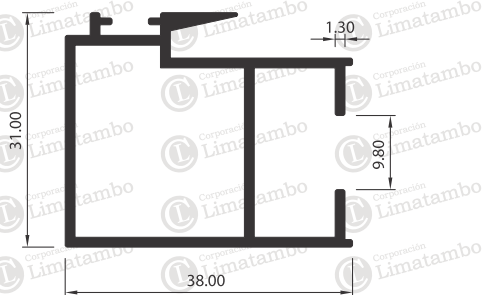

TRASLAPE

2608

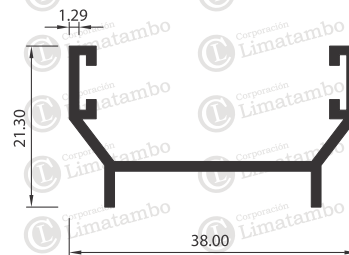

PERFIL ADAPTADOR

2609

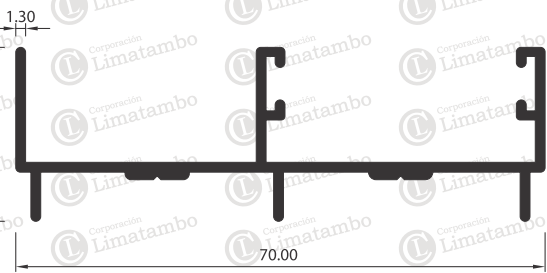

MARCO LATERAL

2610

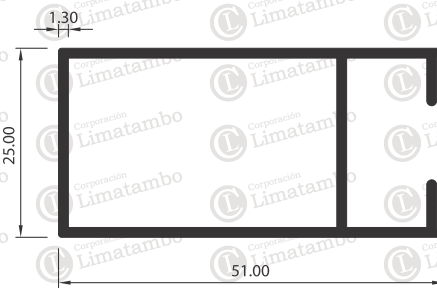

MARCO LATERAL DE HOJA



VL4601

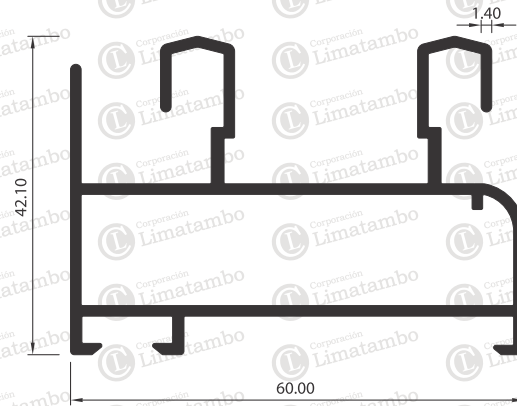

MARCO DOBLE CORREDIZA

VL4604

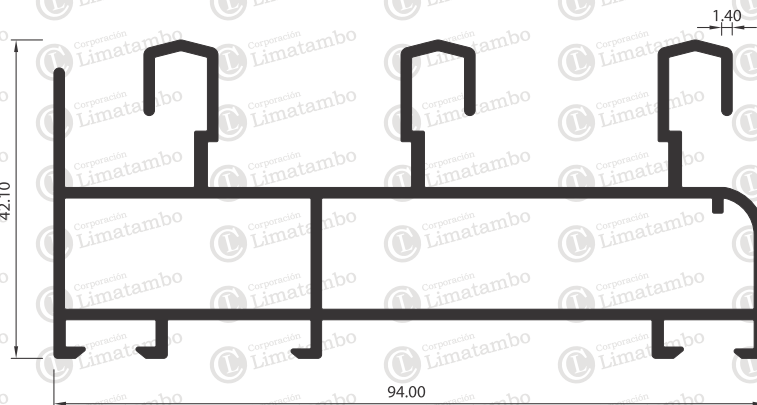

MARCO TRIPLE CORREDIZA



VL4602

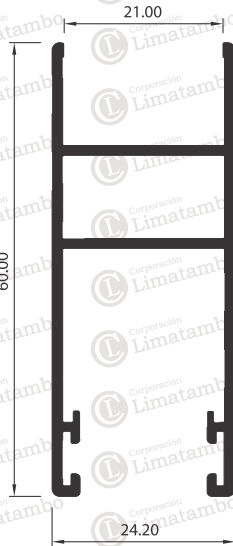

MARCO DE HOJA PARA INSULADO

VL4605

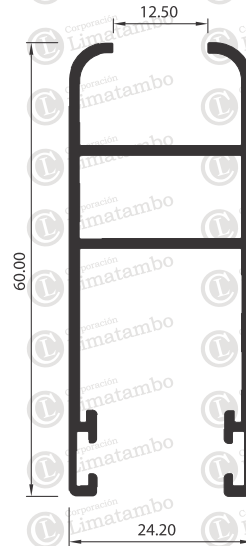

MARCO DE HOJA

VL4603

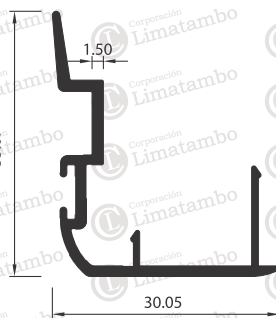

TRASLAPE

VL4606

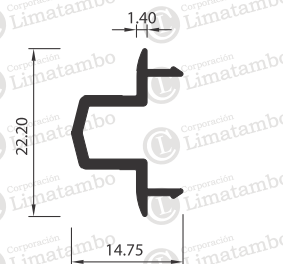

ADAPTADOR DE HOJA



VL4607

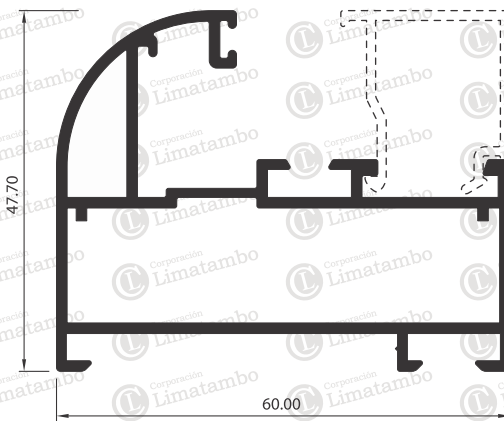

MARCO FIJO

VL4608

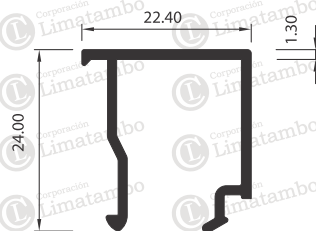

JUNQUILLO DE VIDRIO 6 MM Y 8 MM



ML4601

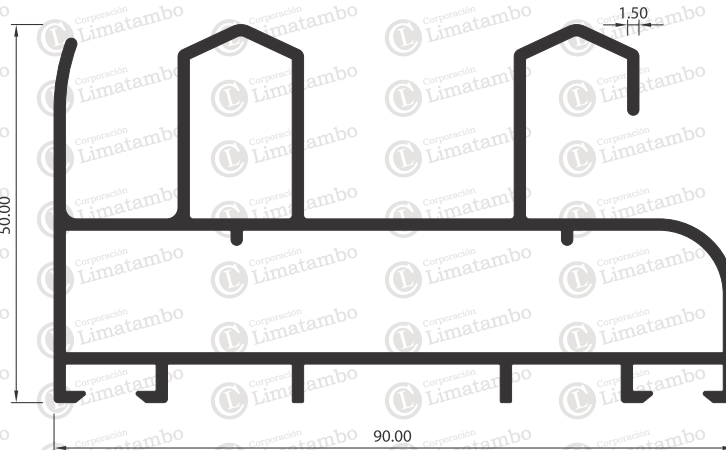

MARCO DOBLE CORREDIZA

ML4604

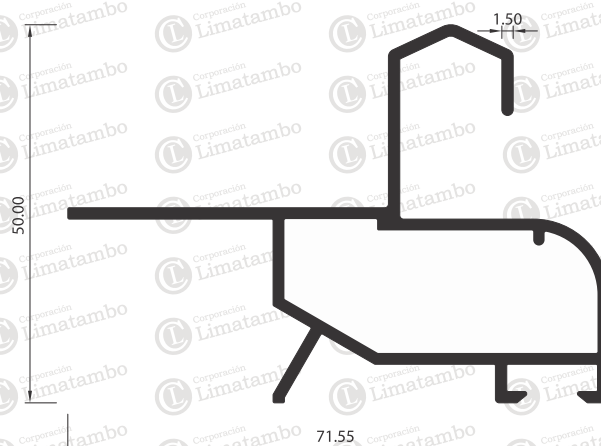

ADAPTADOR MARCO TRIPLE CORREDIZA

CATÁLOGO DE ALUMINIOS

Medidas en mm/ Escala aproximada 1/1
Espesores con tolerancia ± 0.13 mm. aprox.

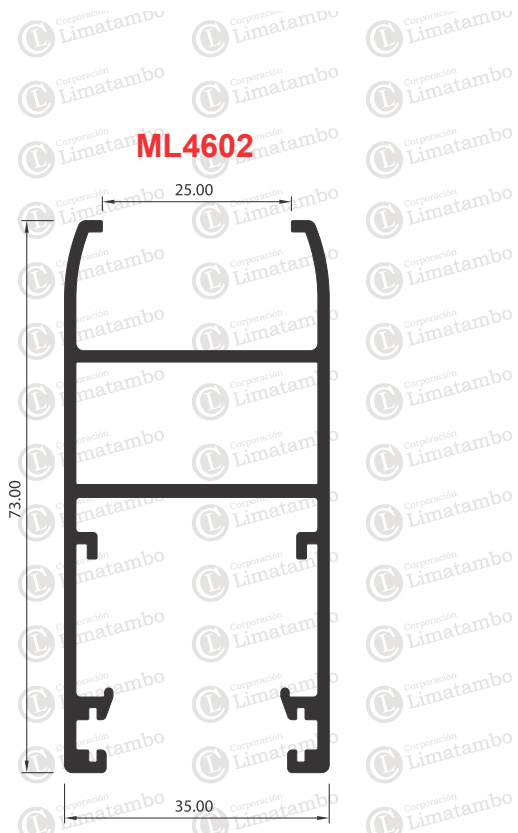

MARCO DE HOJA PARA INSULADO

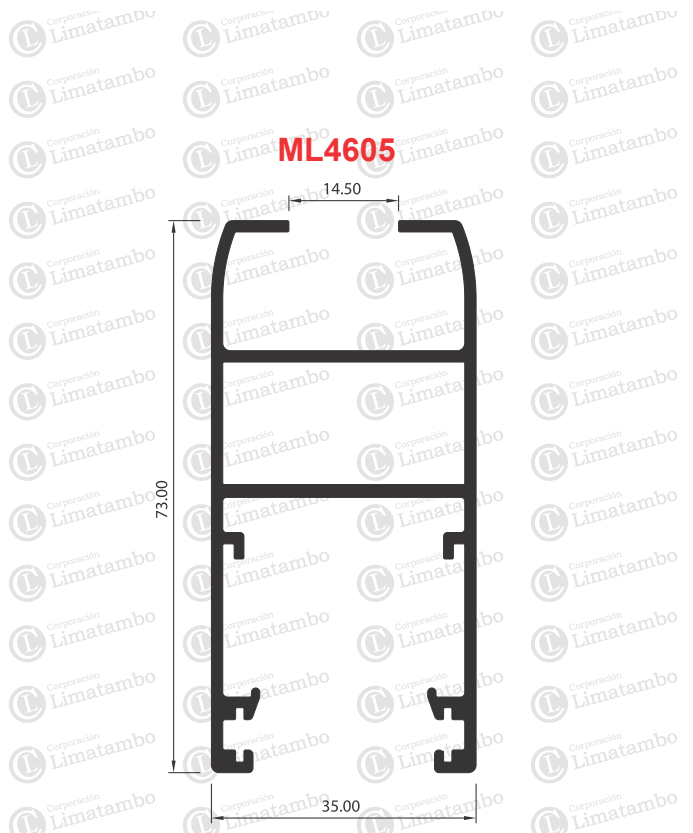

MARCO DE HOJA



TRASLAPE

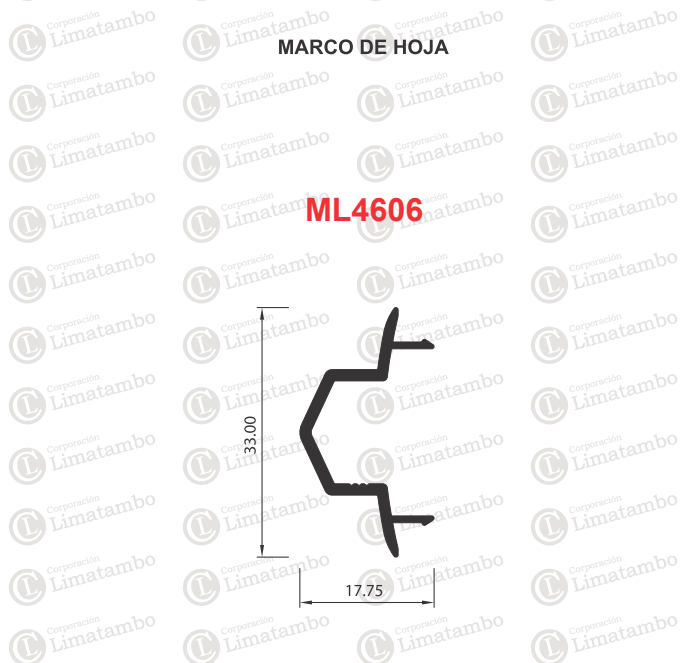

ADAPTADOR DE HOJA



VL4801

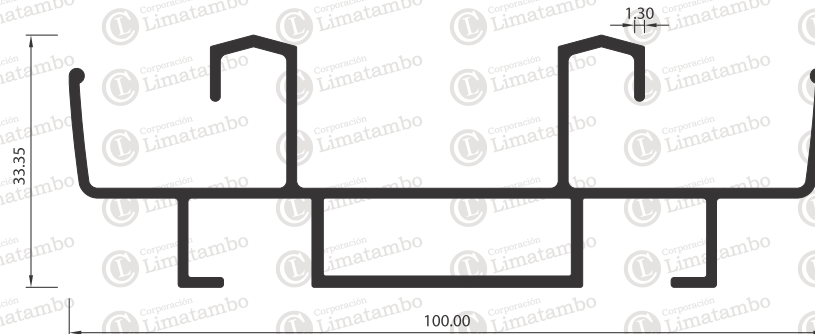

MARCO DOBLE CORREDIZA

VL4803

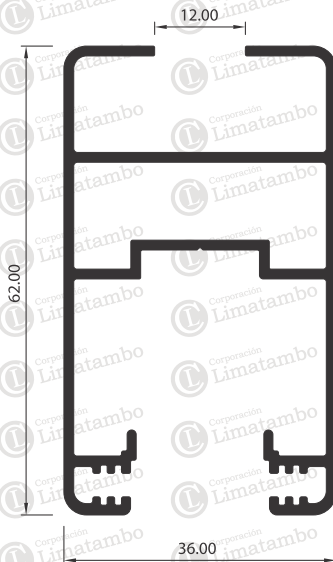

MARCO DE HOJA

VL4804

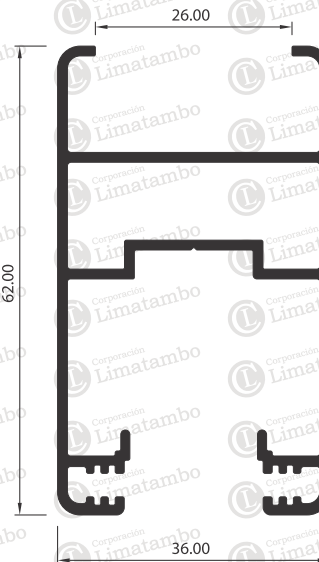

MARCO DE HOJA PARA INSULADO



VL4805

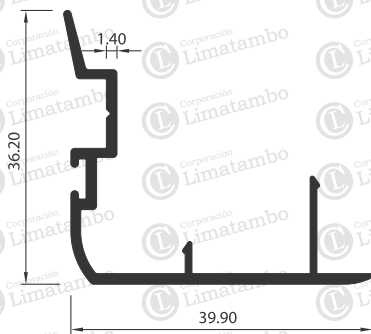

TRASLAPE DE HOJA

VL4806

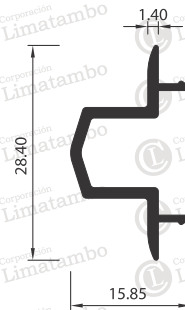

ADAPTADOR DE HOJA

VL4807

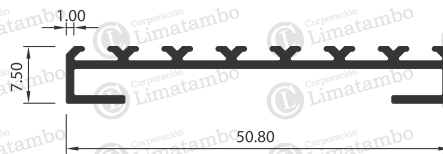

CORTAVIENTO

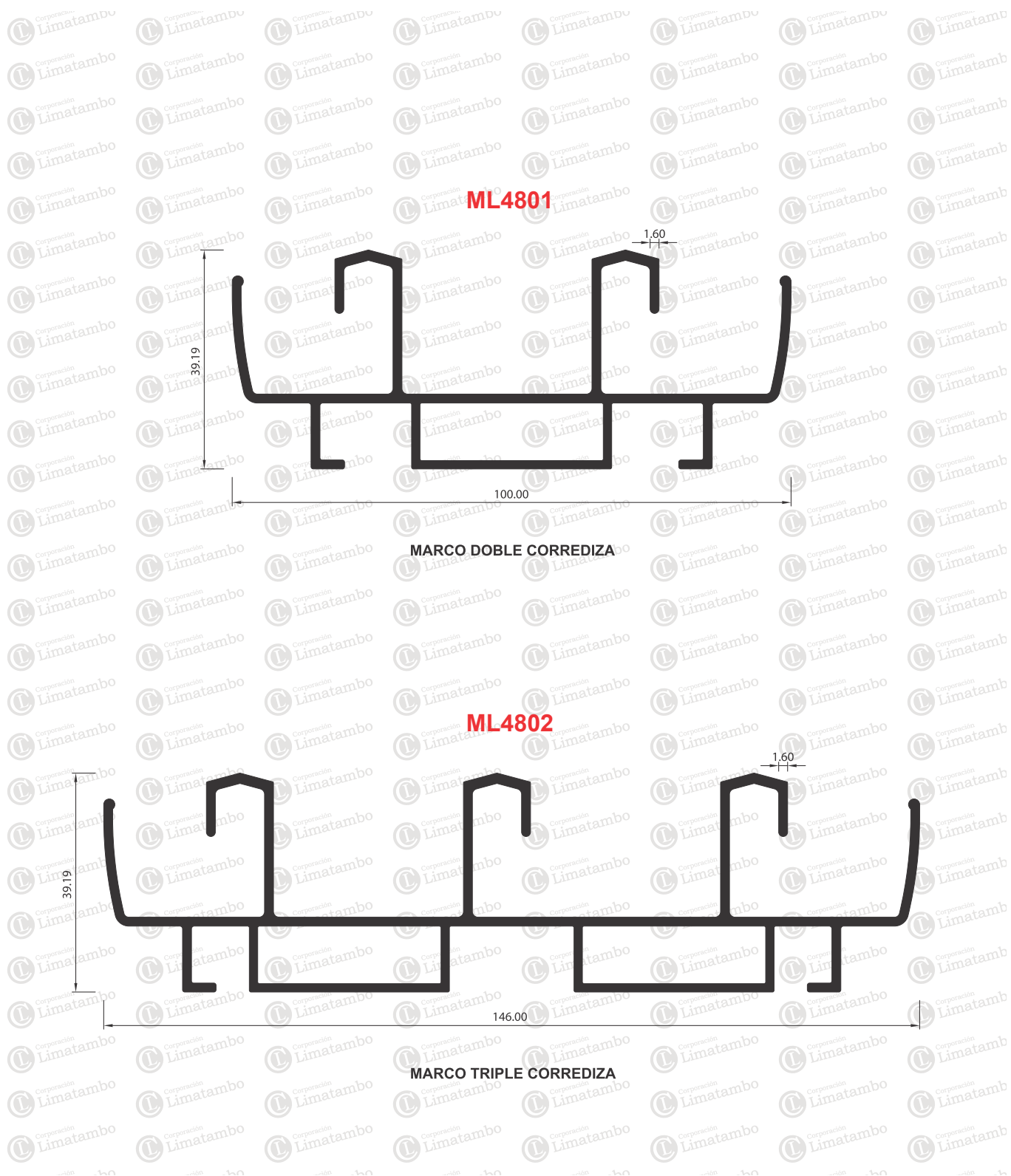

CATÁLOGO DE ALUMINIOS

Medidas en mm/ Escala aproximada 1/1
Espesores con tolerancia ± 0.13 mm. aprox.

ML4803

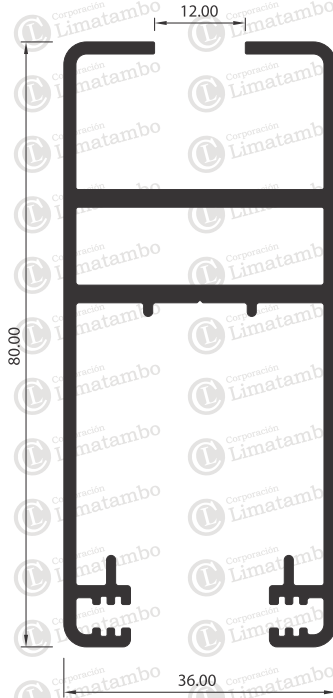

MARCO DE HOJA

ML4804

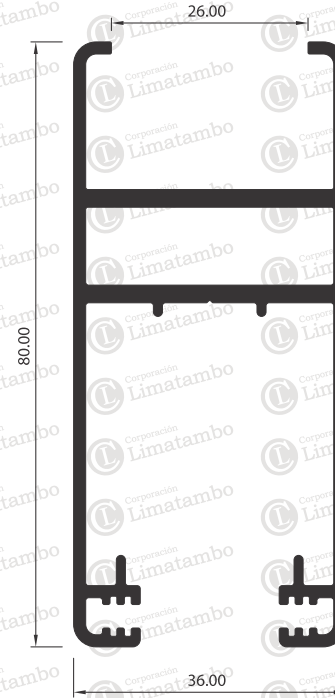

MARCO DE HOJA PARA INSULADO

ML4805

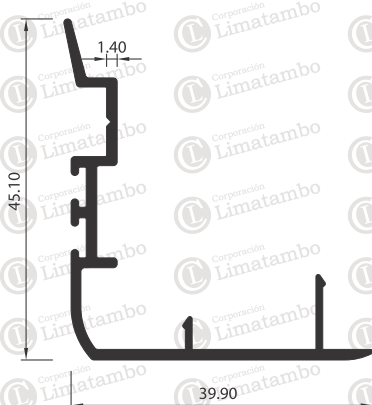

TRASLAPE DE HOJA

VL4806



ADAPTADOR DE HOJA

VL4807

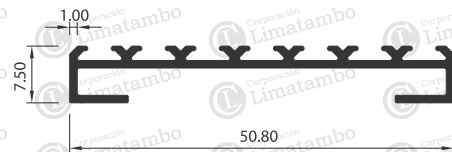

CORTAVIENTO

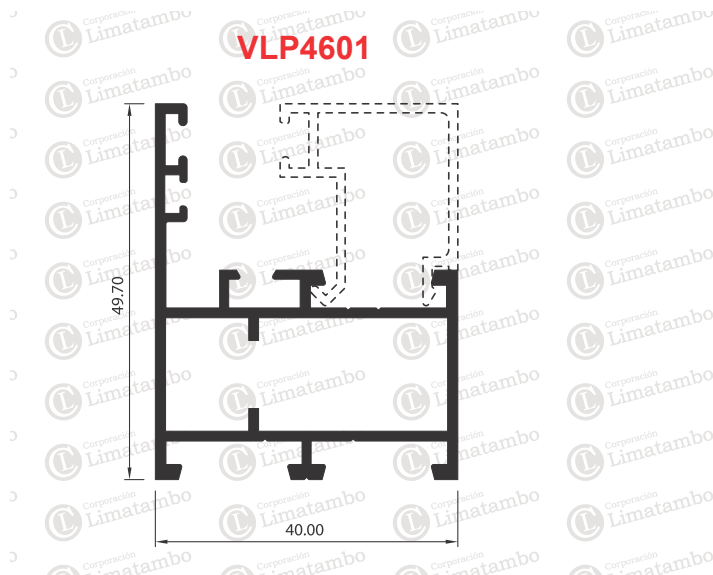

MARCO VENTANA

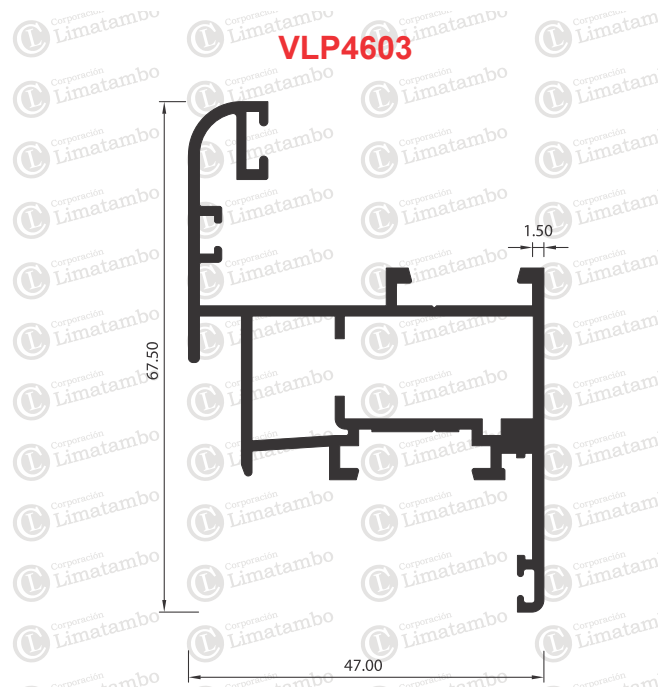

**HOJA DE VENTANA
APERTURA INTERIOR**

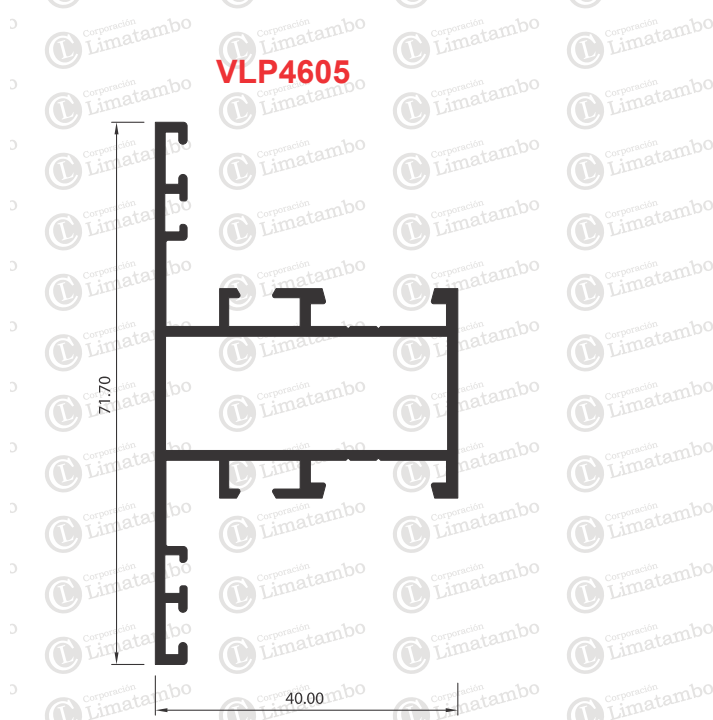

TRAVESAÑO DE VENTANA

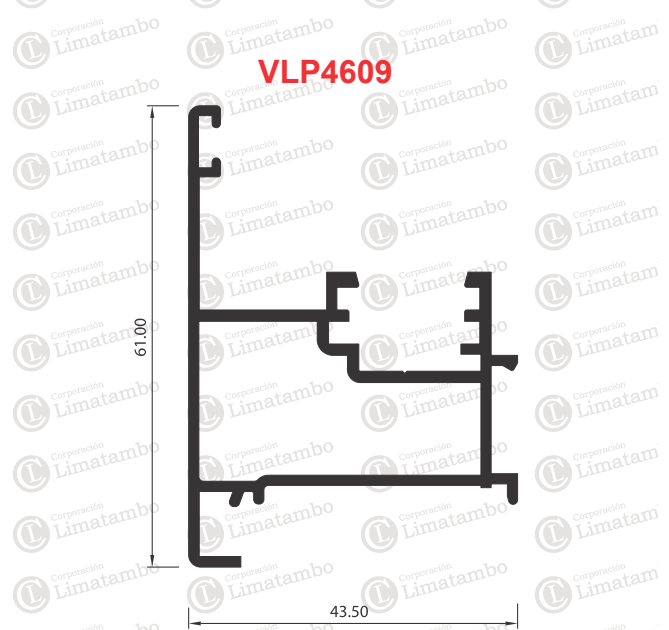

INVERSOR

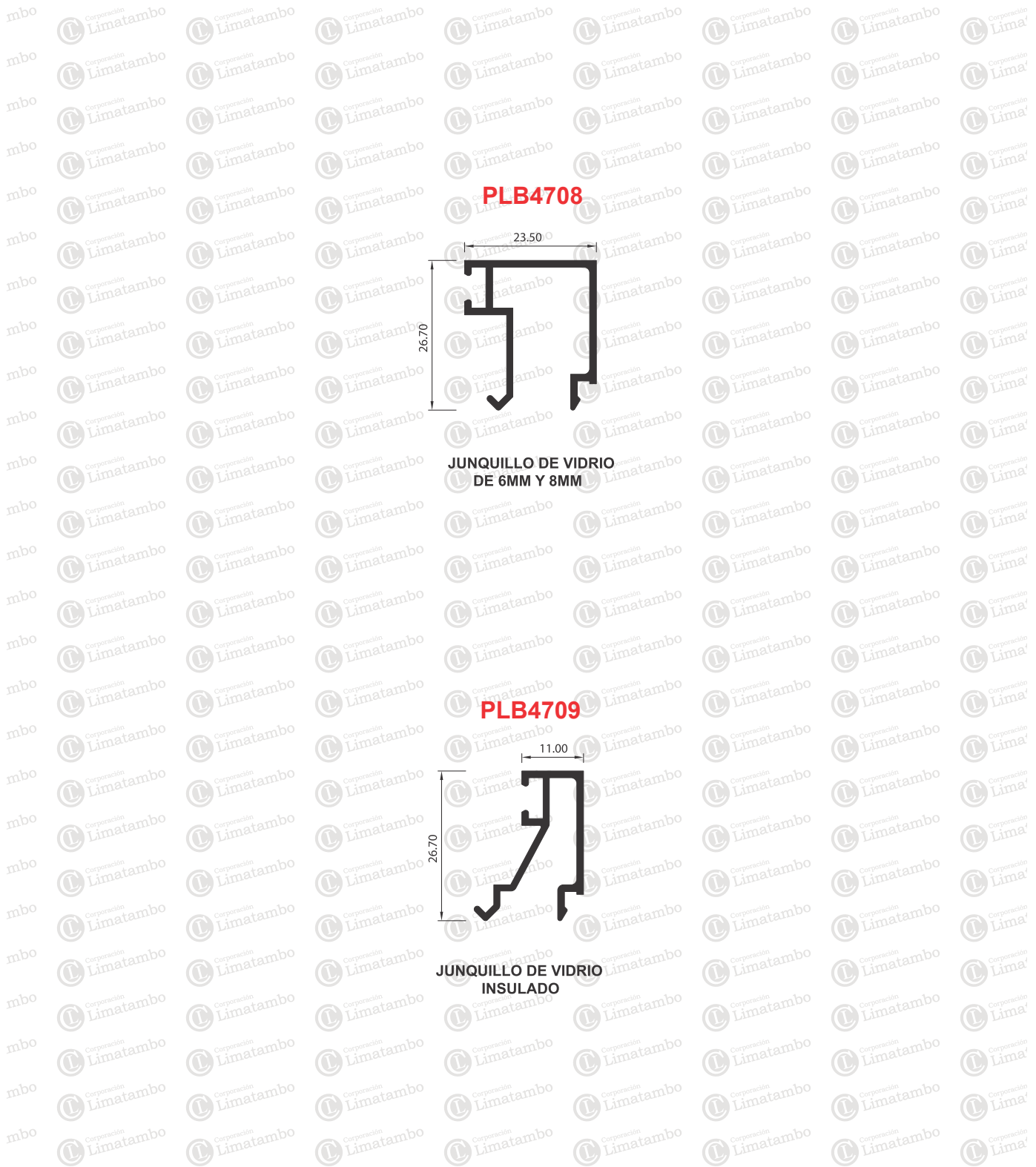

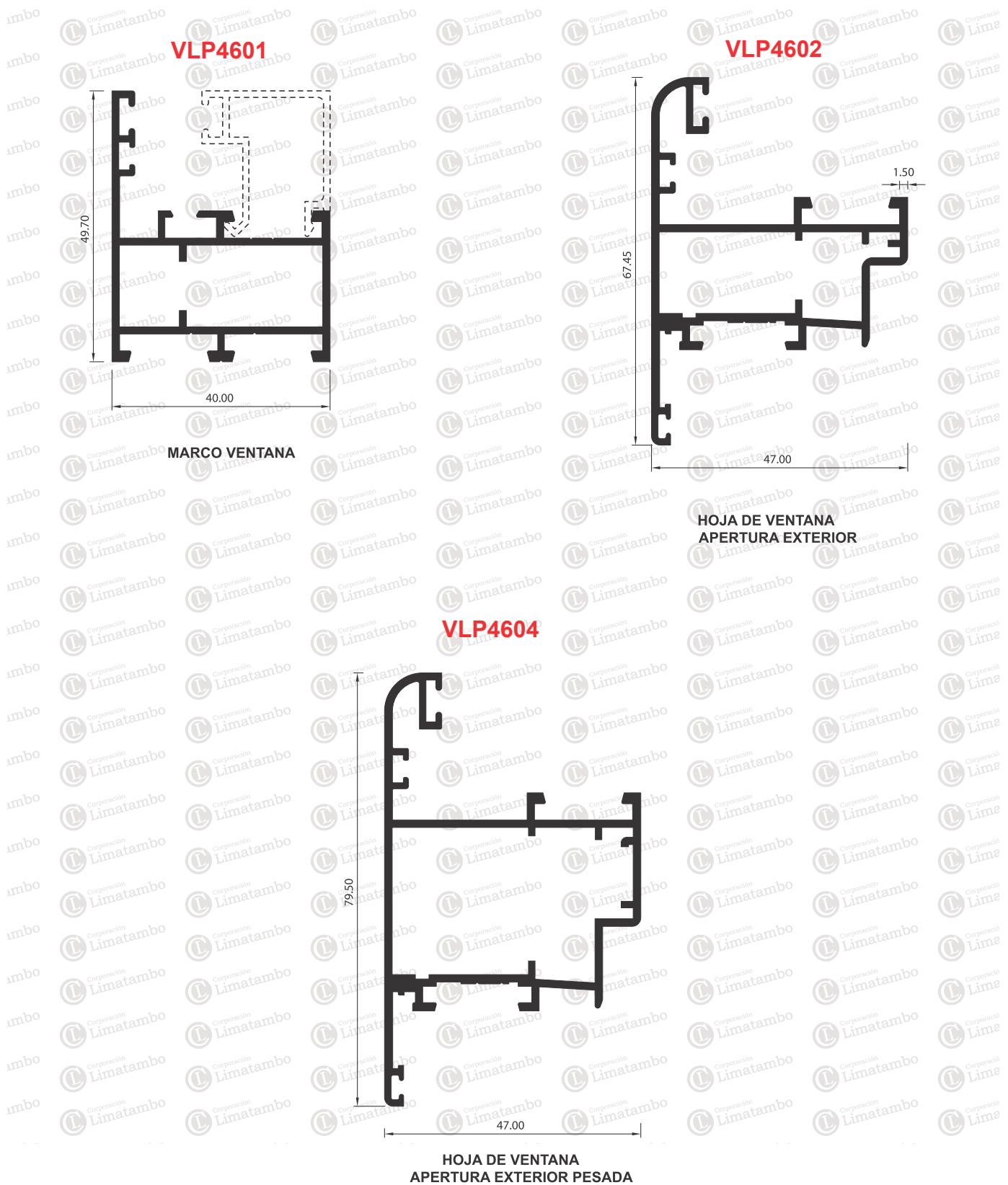

CATÁLOGO DE ALUMINIOS

Medidas en mm/ Escala aproximada 1/1
Espesores con tolerancia ± 0.13 mm. aprox.

VLP4605

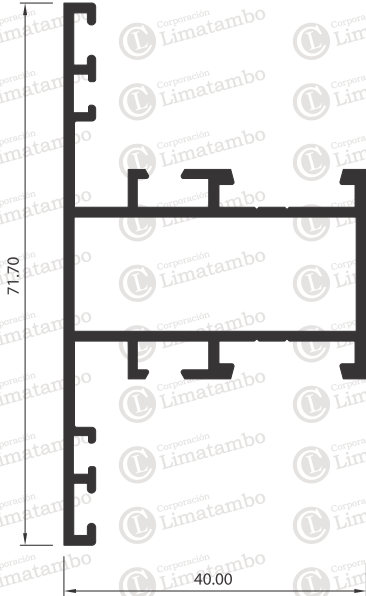

TRAVESAÑO DE VENTANA

VLP4609

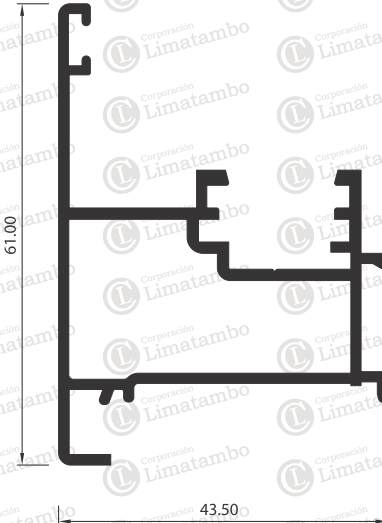

INVERSOR

PLB4708

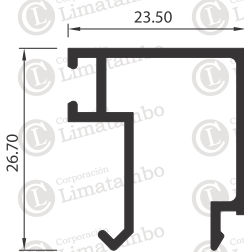

**JUNQUILLO DE VIDRIO
DE 6MM Y 8MM**

PLB4709

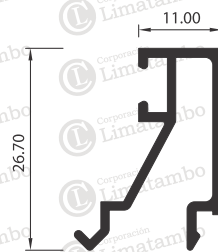

**JUNQUILLO DE VIDRIO
INSULADO**

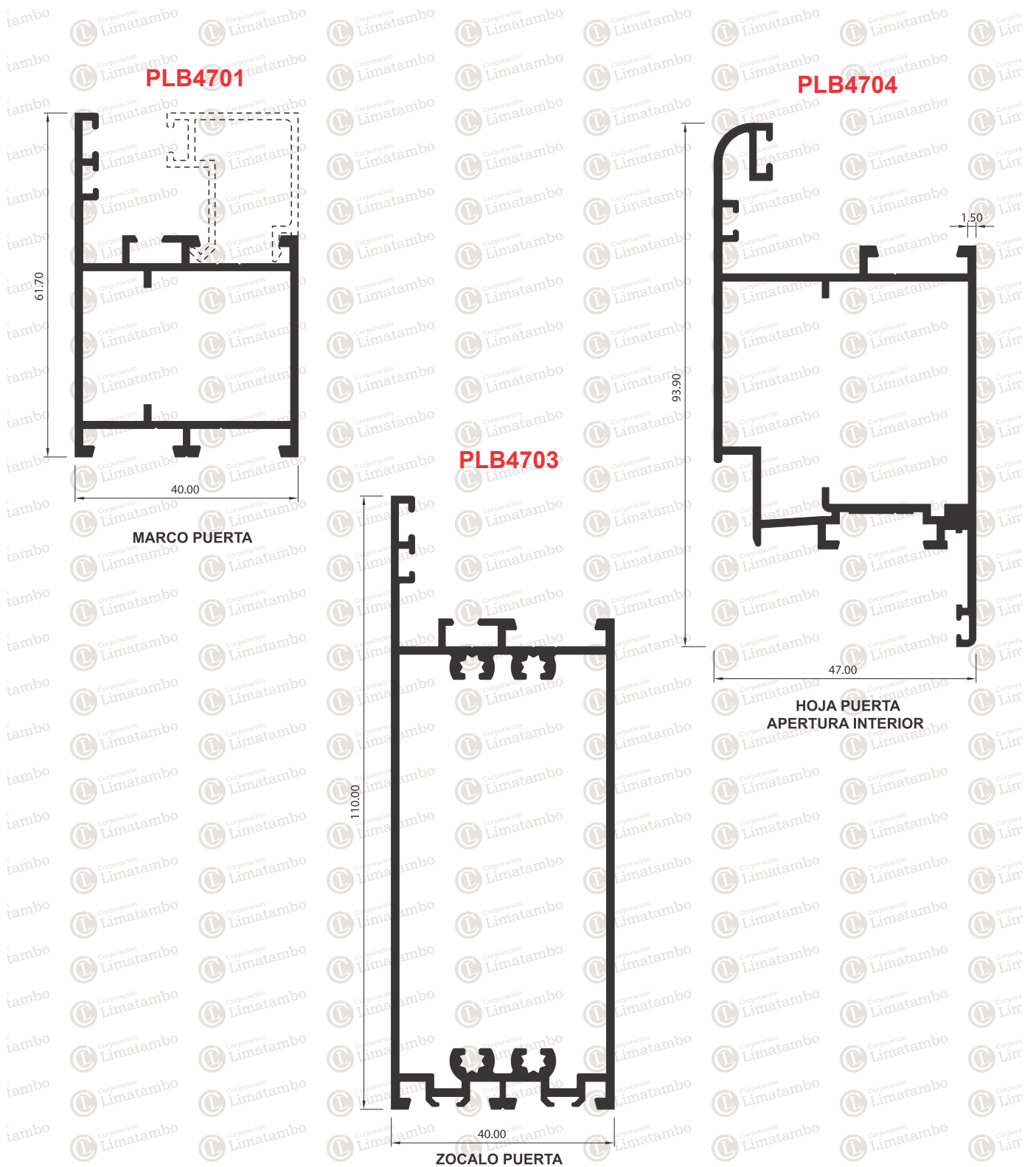

CATÁLOGO DE ALUMINIOS

Medidas en mm/ Escala aproximada 1/1
Espesores con tolerancia ± 0.13 mm. aprox.

PLB4705

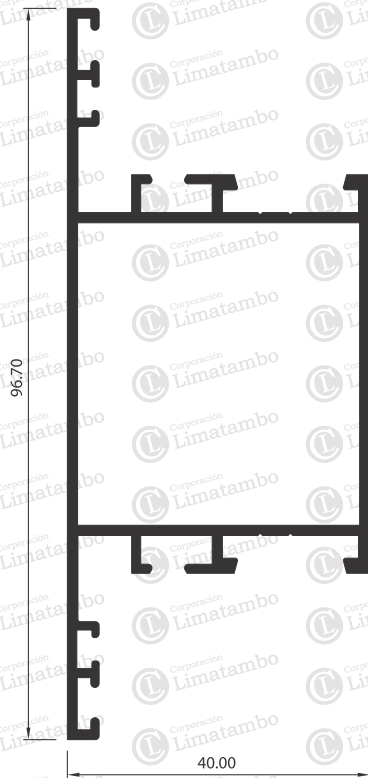

TRAVESAÑO DE PUERTA

VLP4609

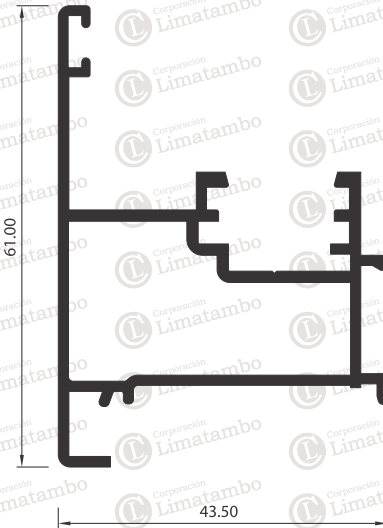

INVERSOR

PLB4708

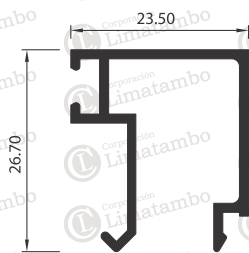

JUNQUILLO DE VIDRIO
DE 6MM Y 8MM

PLB4709

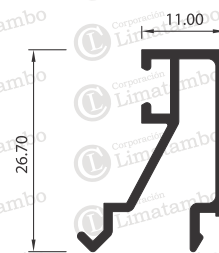

JUNQUILLO DE VIDRIO
INSULADO



**RIEL INFERIOR EMPOTRADA
PARA PLEGADIZA**

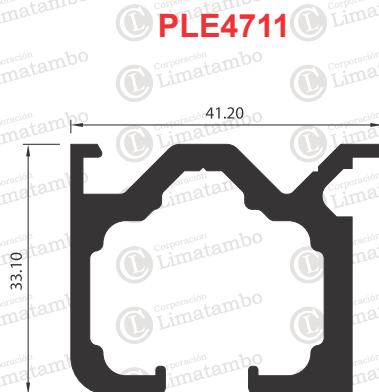

**RIEL SUPERIOR
PARA PLEGADIZA**

**NOTA: PARA EL SISTEMA PLEGABLE, SE TIENE QUE ADICIONAR
LOS PERFILES DE LA PUERTA APERTURA INTERIOR PLB47
(PAG. 93 Y 94)**

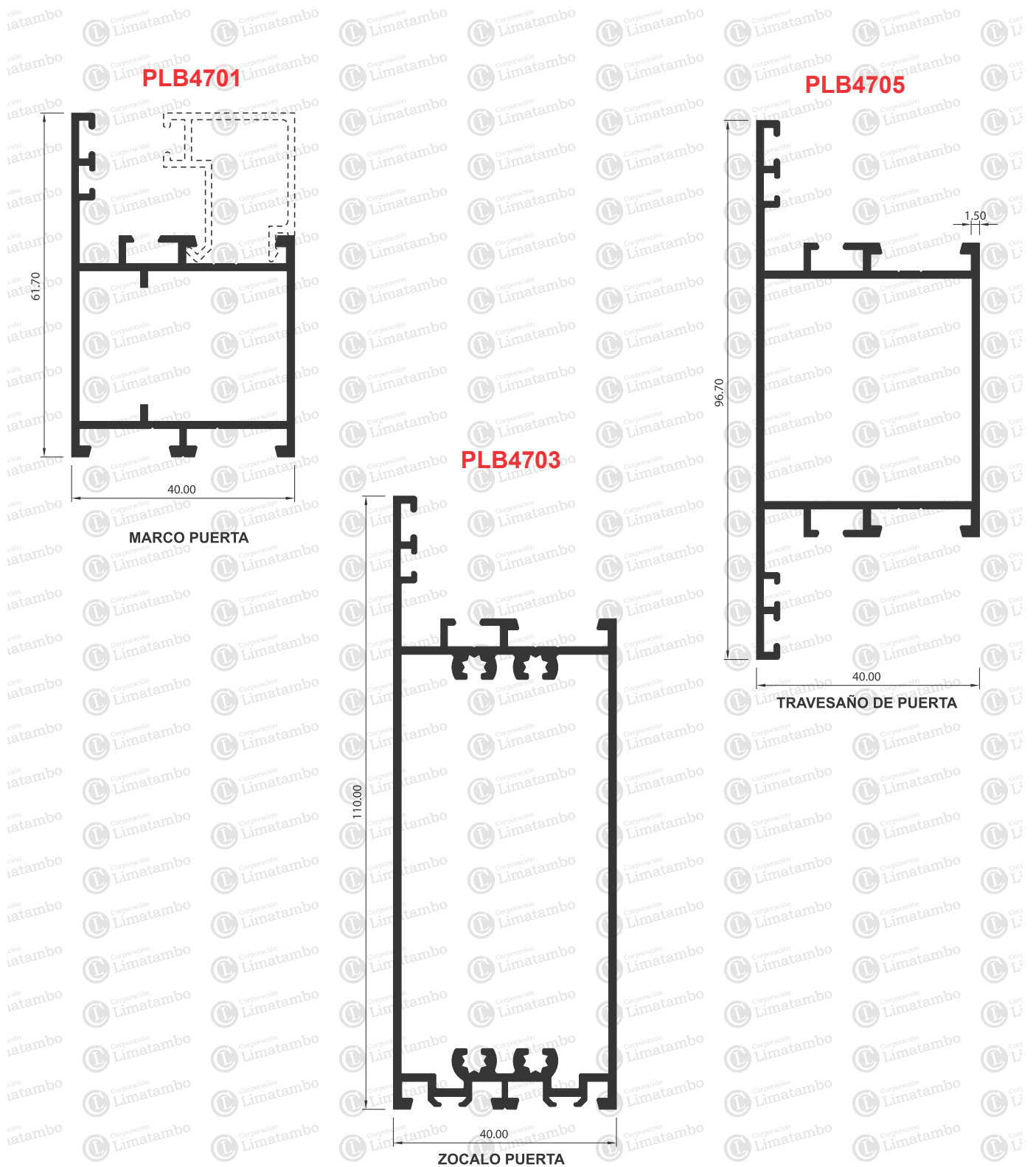

PLB4706

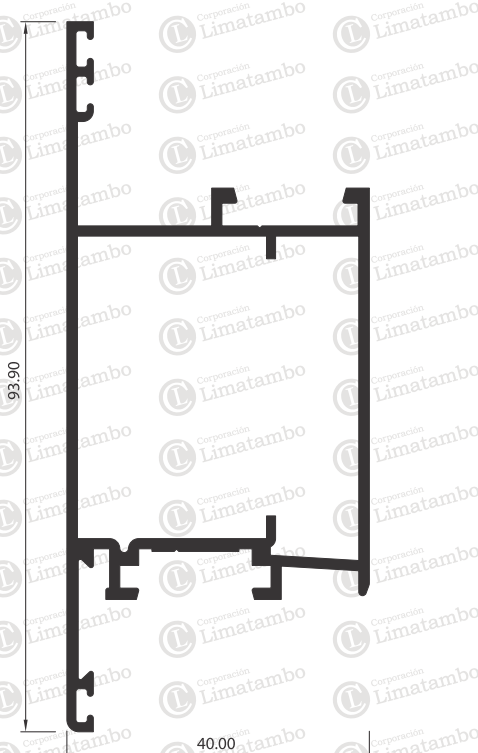

**HOJA PUERTA
APERTURA EXTERIOR**

VLP4609

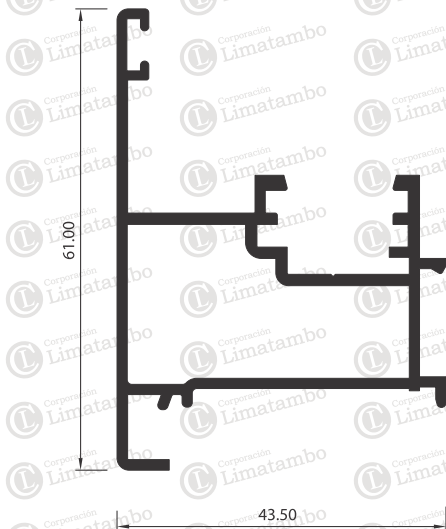

INVERSOR

PLB4708

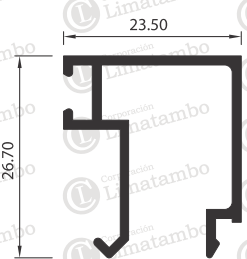

**JUNQUILLO DE VIDRIO
DE 6MM Y 8MM**

PLB4709

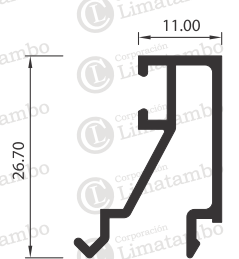

**JUNQUILLO DE VIDRIO
INSULADO**

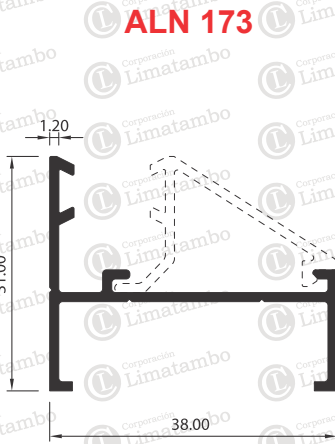

MARCO PROYECTANTE

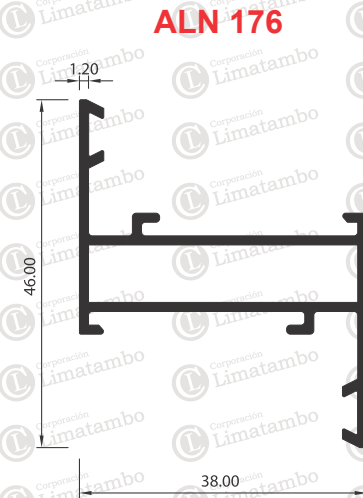

MARCO NAVE

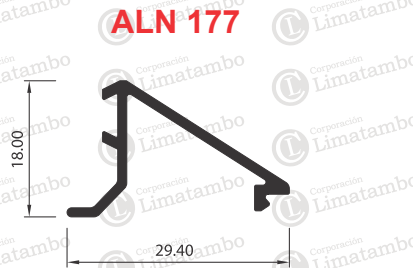

JUNQUILLO

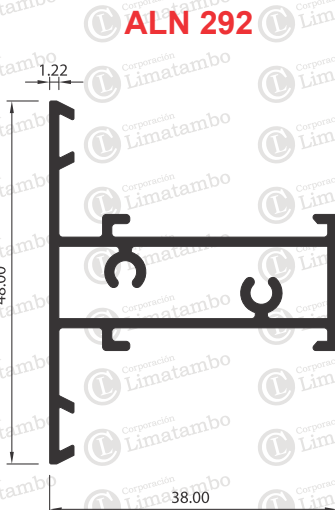

TRAVESAÑO

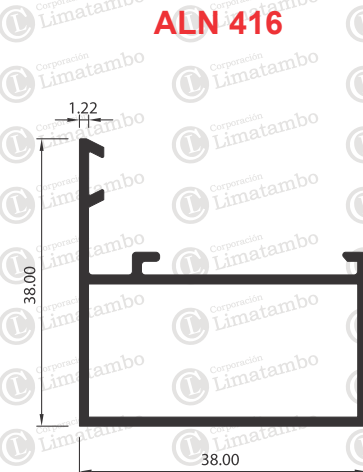

NAVE

3601

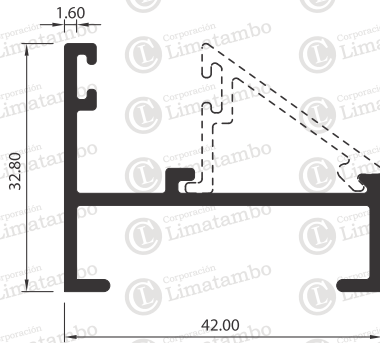

MARCO PROYECTANTE

3602

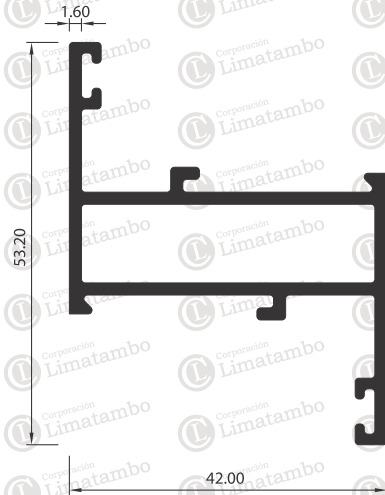

CONTRAMARCO

3603

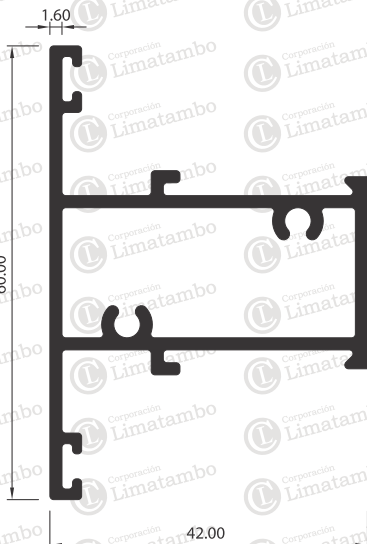

TRAVESAÑO

3604

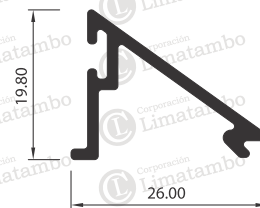

JUNQUILLO

CATÁLOGO DE ALUMINIOS

Medidas en mm/ Escala aproximada 1/1
Espesores con tolerancia ± 0.13 mm. aprox.

3606

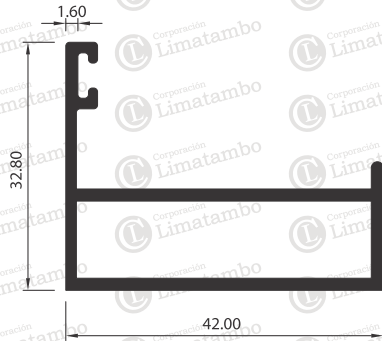

MARCO

3607

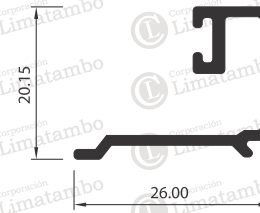

JUNQUILLO PARA INSULADO

3609

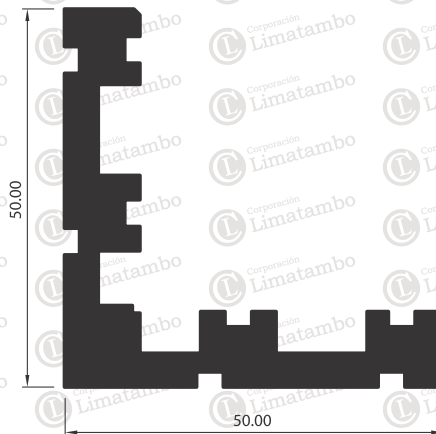

ÁNGULO RANURADO

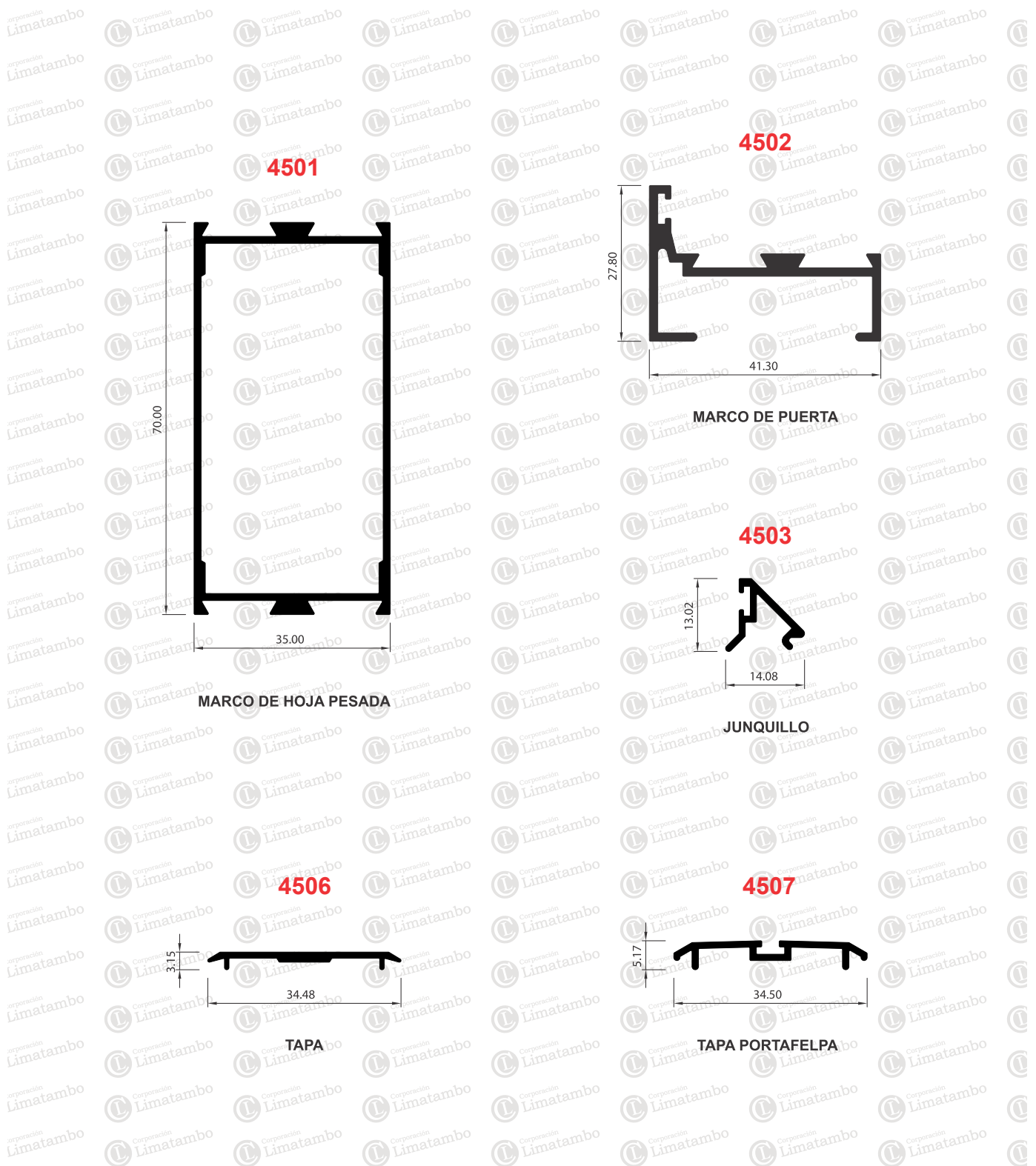

CATÁLOGO DE ALUMINIOS

Medidas en mm/ Escala aproximada 1/1
Espesores con tolerancia ± 0.13 mm. aprox.



4508

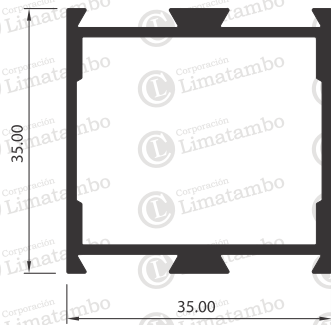

MARCO DE HOJA LIVIANA

4509

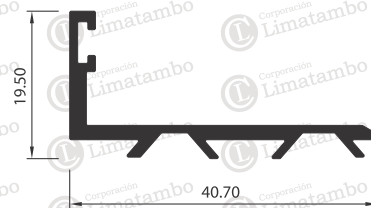

TOPE CON PORTAFELPA

4510

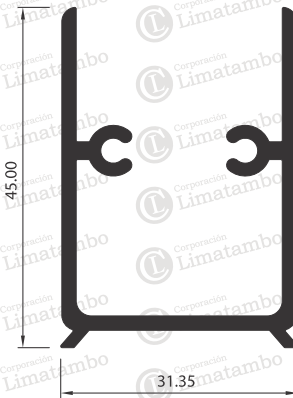

SOPORTE DE ARMADO

MBL4600

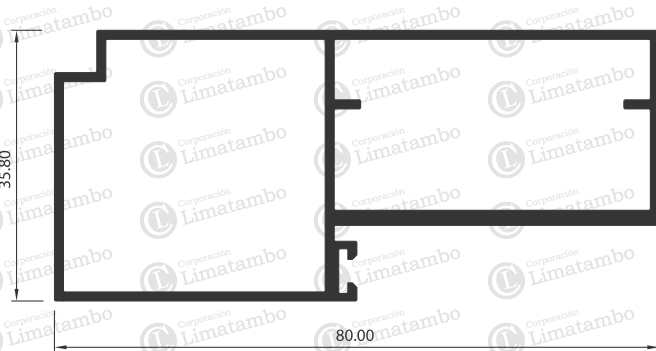

MARCO PUERTA

MBL4601

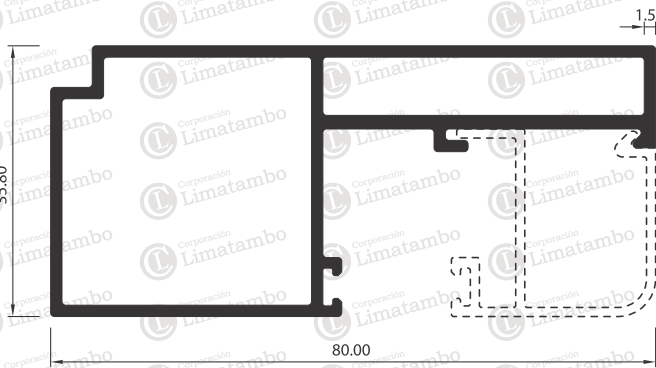

MARCO LATERAL



MBL4602

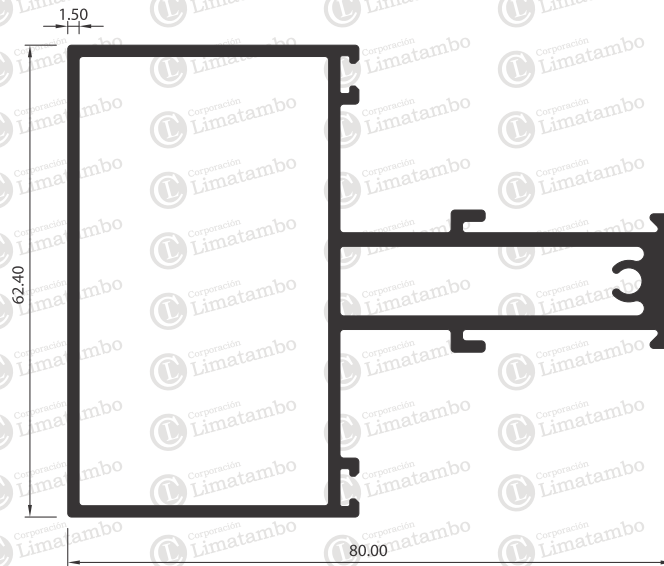

MARCO CENTRAL



MBL4603

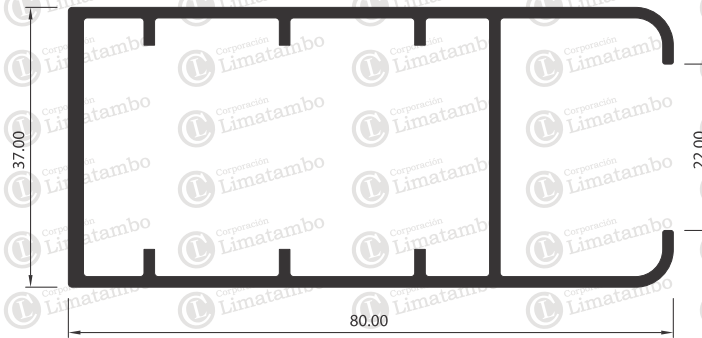

MONTANTE DE HOJA LIVIANA

MBL4604

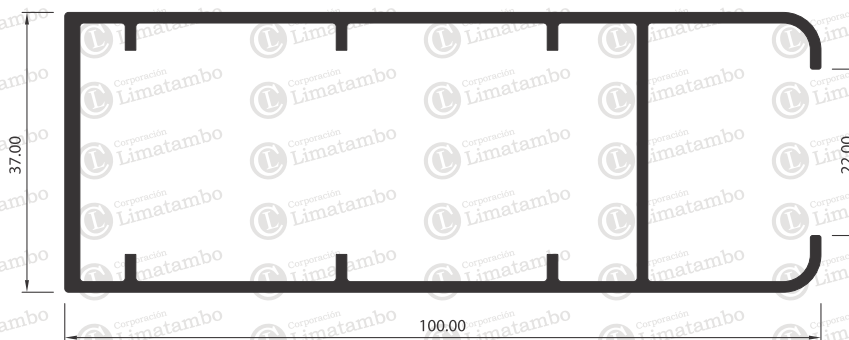

MONTANTE DE HOJA PESADA



MBL4606

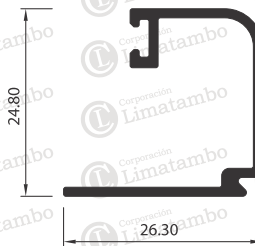

JUNQUILLO 18MM

MBL4608

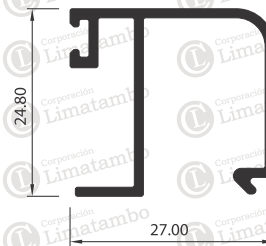

JUNQUILLO 8MM

MBL4609

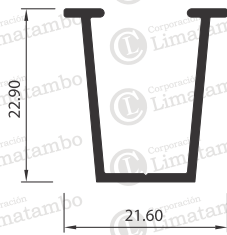

ADAPTADOR CRISTAL SIMPLE

MBL4610



TOPE CENTRAL

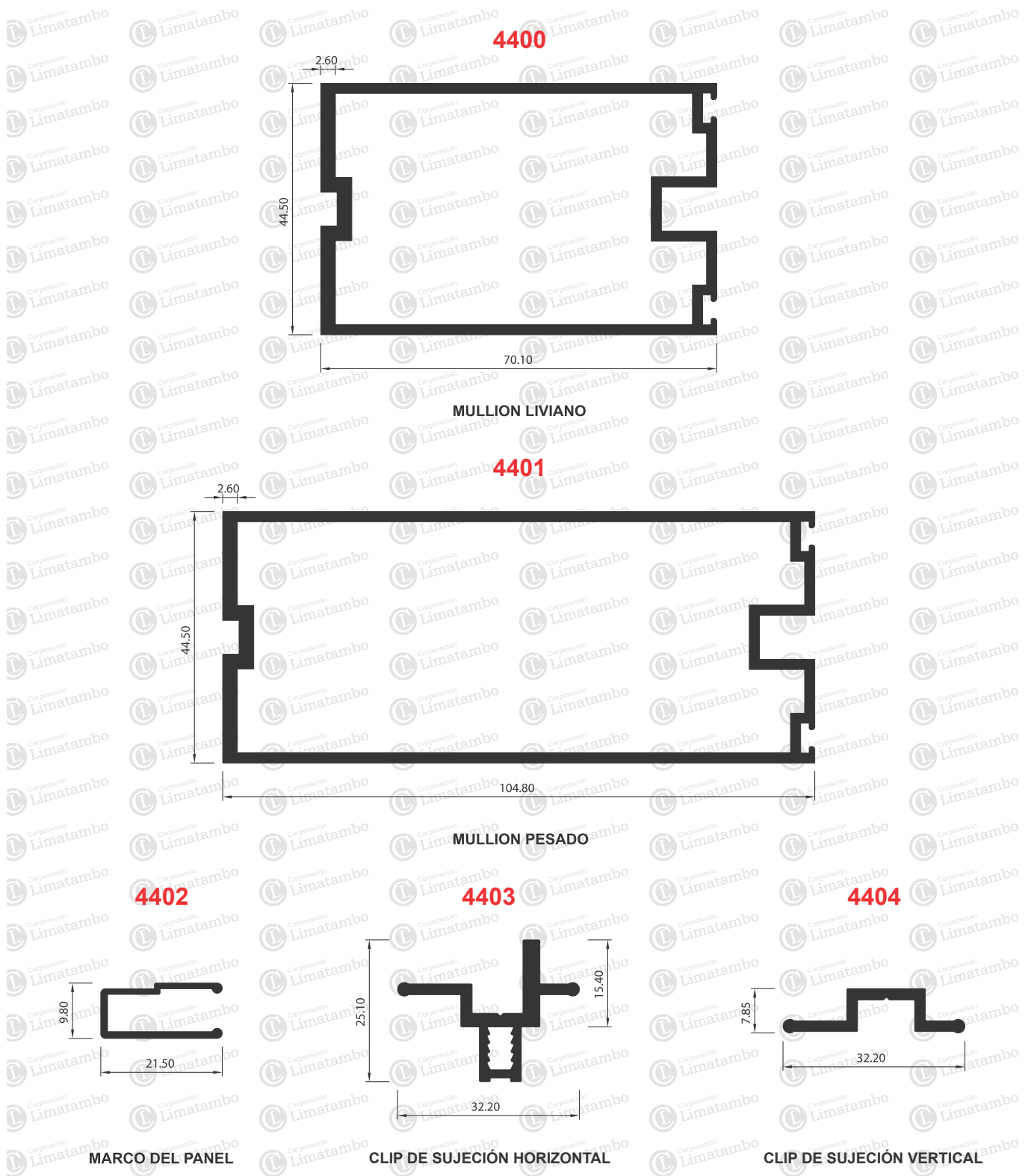

CATÁLOGO DE ALUMINIOS

Medidas en mm/ Escala aproximada 1/1
Espesores con tolerancia ± 0.13 mm. aprox.

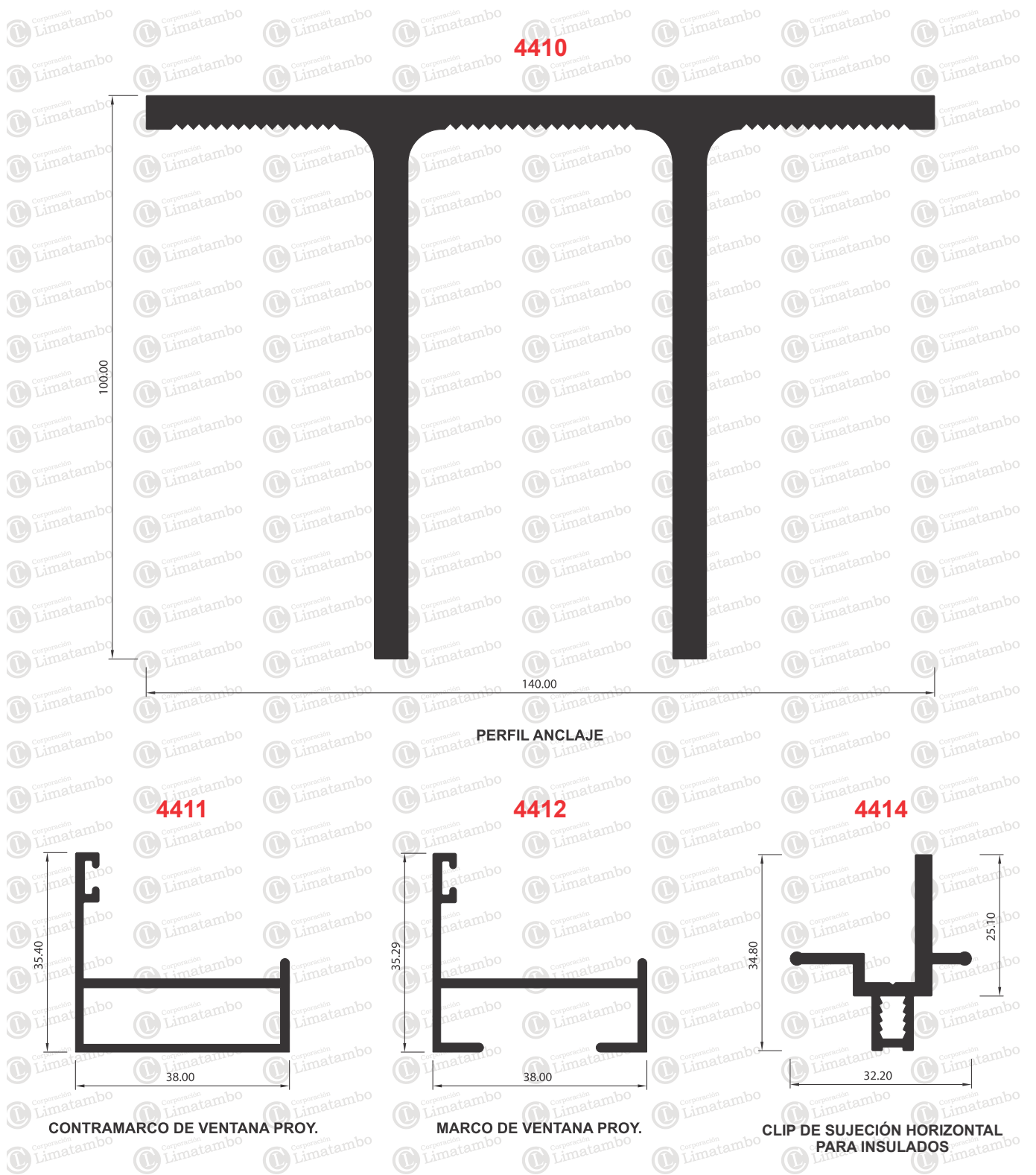



PLANTA DE VIDRIOS TEMPLADOS

Av. Próceres de la Independencia 3201 - SJL
Telf: (01) 338 2282

LA VICTORIA

Av. Paseo de la República 1427 - La Victoria
Cel: 998265003 / 933429483

Av. México 512 Urb. Balconcillo - La Victoria
Telf: (01) 472 4195

SAN JUAN DE LURIGANCHO

Av. Próceres de la Independencia 1994 - SJL
Telf: (01) 376 6159

ALMACÉN BAMBÚES

Av. Los Bambúes Mz X Lote 13
Urb. Canto Grande - SJL

ALMACÉN CENTRAL

Av. Del Parque 857 - SJL

ALMACÉN LOS CÓNDORES

Av. Los Regadores Mz B lote 14
Urb. Zárate Industrial - SJL

